

IKA

laboratory equipment
designed for scientists

EN

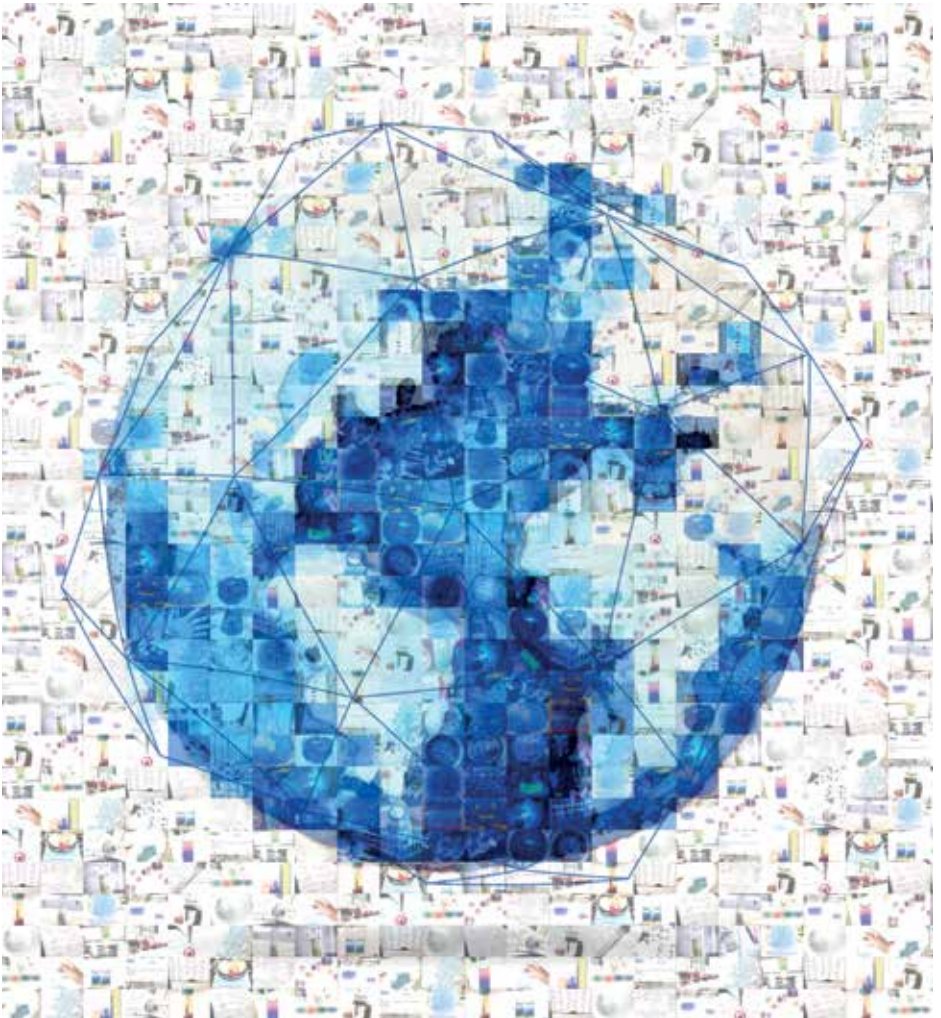

Product Overview 2016/2.

THE FASCINATING WORLD OF LABORATORY EQUIPMENT.

We are committed to providing innovations that make your work safer, future-oriented and smarter.

/// Discover the fascinating world of laboratory equipment and analytical technologies.

IKA is a world leader in the laboratory equipment and analytical technology segment. With our background of more than 100 years of experience, we possess long-established and proven expertise in the development of innovative products for virtually all kinds of laboratories throughout the world.

The exceptional motivation and creativeness of our more than 800 employees is a vital factor in the development of new products as well as in the realization of new technologies that ensure our customers' greater safety and competitive edge.

Our cover is a collage of featured pictures of our Instagram followers from around the globe. We thank you for your inspiration.

 IKAworldwide
  IKAworldwide /// #lookattheblue
  @IKAworldwide



4
/// MIXING

Magnetic Stirrers	4
Overhead Stirrers	28
Shakers	42



62
/// CRUSHING

Dispersers	64
Mills	88



100
/// HEATING/TEMPERING

Dry Block Heaters	100
Hotplates	106
Heating Baths	108
Temperature control	110

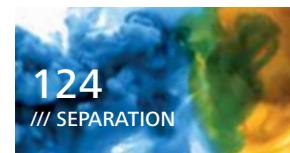

124
/// SEPARATION

Centrifuge	124
Rotary Evaporators	126



138
/// MECHANICAL /
ELECTRONIC ACCESSORIES

Accessories	138
-------------	-----

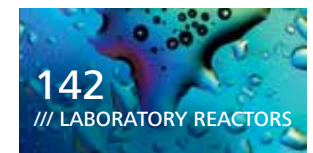

142
/// LABORATORY REACTORS

Laboratory Reactors	142
---------------------	-----



154
/// SOFTWARE

labworldsoft®	155
CalWin	155



158
/// ANALYTICAL TECHNOLOGY

Calorimeters	158
--------------	-----



170
/// PACKAGES

Packages	170
----------	-----

Magnetic Stirrers



IKA® magnetic stirrers are made for Scientists. When a product is developed, the engineers focus on safety, power and intelligence. There is a complete range of magnetic stirrers to handle various tasks, applications and quantities, either with or without heating capabilities and with open or closed vessels. IKA® stirrers require up to 25% less energy than other manufacturer's products.

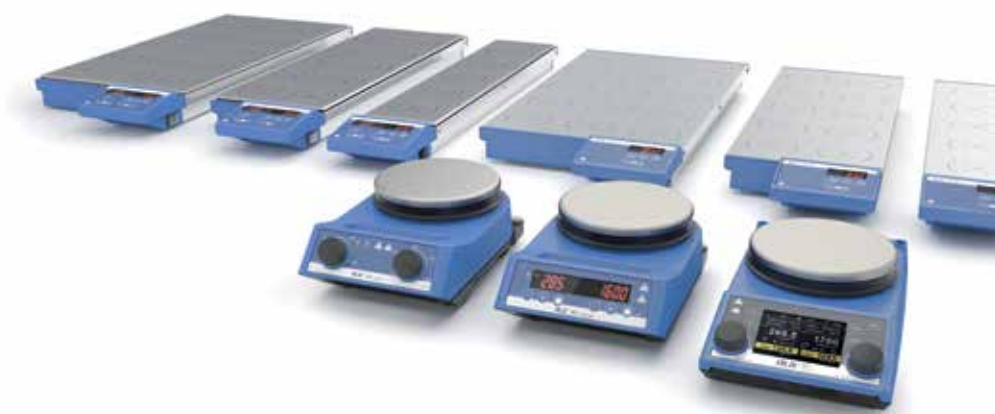

Patented

RET® control-visc with white coated heating plate!

- > Offers excellent chemical resistance
- > Easy to clean

RET® control-visc



Integrated temperature sensor for precise temperature control



Integrated weighing function allows the user to measure weight changes of up to 5,000 g

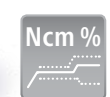

Torque trend measurement
Viscosity changes in the medium can be measured by using a torque measurement device. The results can be depicted on the display



USB/RS 232 interface for connecting a PC, using labworldsoft® and enabling online updates of device software



Magnetic Stirrers with heating



RH basic / digital with white coated heating plate

- > Offers excellent chemical resistance
- > Easy to clean



Technical data	RH basic 2	RH basic RH basic white	RH digital RH digital white
Max. stirring quantity (H ₂ O)	10 l	15 l	15 l
Motor rating input / output	15 W	20 / 2 W	20 / 2 W
Speed range	100 – 2000 rpm	100 – 2000 rpm	100 – 2000 rpm
Speed display	scale (0 – 6)	scale	LED
Heat output	400 W	600 W	600 W
Temperature range	RT – 320 °C	50 – 320 °C	50 – 320 °C
Max. magnetic bar (L x Ø)	50 mm	80 mm	80 mm
Safety circuit	400 °C (fixed)	100 – 360 °C	100 – 360 °C
Control accuracy with sensor	–	ETS-D5: ± 0.5 K ETS-D6: ± 0.2 K	ETS-D5: ± 0.5 K ETS-D6: ± 0.2 K
Heating plate material	stainless steel 1.4301	stainless steel 1.4301 white ceramic	stainless steel 1.4301 white ceramic
Set-up plate dimensions	Ø 125 mm	Ø 135 mm	Ø 135 mm
Weight	2.4 kg	2.8 kg	2.8 kg
Price	343.- EUR	449.- EUR 493.- EUR	564.- EUR 588.- EUR
	Ident. No. 0003339000	Ident. No. 0005019700 Ident. No. 0005029700	Ident. No. 0005019800 Ident. No. 0004678000



Watch the video:
www.ika.com/video



Technical data	RCT basic	RET basic
Max. stirring quantity (H ₂ O)	20 l	20 l
Motor rating input / output	16 / 9 W	16 / 9 W
Speed range	50 – 1500 rpm	50 – 1700 rpm
Heat output	600 W	600 W
Temperature range	RT – 310 °C	RT – 340 °C
Adjustable safety circuit	50 – 360 °C	50 – 360 °C
Control accuracy with sensor	PT 1000: ± 1 K ETS-D5: ± 0.5 K ETS-D6: ± 0.2 K	PT 1000: ± 1 K ETS-D5: ± 0.5 K ETS-D6: ± 0.2 K
Heating plate material	aluminum alloy	stainless steel 1.4301
Set-up plate dimensions	Ø 135 mm	Ø 135 mm
Dimensions (W x D x H)	160 x 270 x 85 mm	160 x 270 x 95 mm
Weight	2.5 kg	2.5 kg
Price	697.- EUR	996.- EUR
	Ident. No. 0003810000*	Ident. No. 0003622000

* PT 1000.60 included in delivery.

Accessories starting page 20 - 27

Magnetic Stirrers with heating



RET® control-visc with white coated heating plate

- > Offers excellent chemical resistance
- > Easy to clean



Watch the video:
www.ika.com/video



Technical data	RET® control-visc	RET® control-visc white
Max. stirring quantity (H ₂ O)	20 l	20 l
Motor rating input / output	16 / 9 W	16 / 9 W
Speed range	50 – 1700 rpm	50 – 1700 rpm
Heat output	600 W	600 W
Temperature range	RT – 340 °C	RT – 340 °C
Adjustable safety circuit	50 – 380 °C	50 – 380 °C
Control accuracy with sensor	PT 100: ± 0.2 K	PT 100: ± 0.2 K
Heating plate material	stainless steel 1.4301	white ceramic
Set-up plate dimensions	Ø 135 mm	Ø 135 mm
Dimensions (W x D x H)	160 x 270 x 85 mm	160 x 270 x 85 mm
Weight	2.7 kg	2.7 kg
Price	1,262.- EUR	1,290.- EUR
	Ident. No. 0005020000*	Ident. No. 0005030000*

* PT 100.70 included in delivery

Accessories starting page 20 - 27

pH electrode
Possibility to connect pH electrode

TFT Display
TFT display for better image quality and easy navigation

Extra strong heating

Integrated temperature sensor
for precise temperature control

Torque trend measurement
Viscosity changes in the medium can be measured by using a torque measurement device. The results can be depicted on the display

Phil S. Baran Ph.D.
Darlene Shiley Professor
The Scripps Research Institute -
La Jolla, CA, USA

Patented

Integrated weighing function allows the user to measure weight changes of up to 5,000 g

USB interface to control and document all parameters using labworldsoft® software and for updating your firmware

The Magnetic Stirrer for Scientists

Strongest and safest magnetic stirrer in its class with integrated weighing function and torque trend measurement

Magnetic Stirrers with heating



Watch the video now:
www.ika.com/video



C-MAG
HS 7



DIN Bushing 12878 for connecting an electronic contact thermometer



Elevated control panel for protection against spilled liquids



Hot Top indicator to prevent burns



Ceramic set-up plate offers excellent chemical resistance to acid, bases and solvents

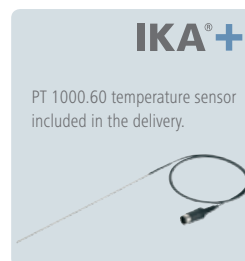

IKA+

PT 1000.60 temperature sensor included in the delivery.



Elevated control panel for protection against spilled liquids



LCD display for simultaneous display of target and actual temperatures



Ceramic set-up plate offers excellent chemical resistance to acid, bases and solvents



Hot Top indicator to prevent burns



Integrated temperature sensor for precise temperature control

C-MAG
HS 7
digital



	C-MAG HS 4	C-MAG HS 7	C-MAG HS 10
Technical data			
Max. stirring quantity (H ₂ O)	5 l	10 l	15 l
Motor rating input / output	15 / 1.5 W	15 / 1.5 W	15 / 1.5 W
Speed range	100 – 1500 rpm	100 – 1500 rpm	100 – 1500 rpm
Heat output	250 W	1000 W	1500 W
Temperature range	50 – 500 °C	50 – 500 °C	50 – 500 °C
Display	LED	LED	LED
Max. stirring bar length	30 mm	80 mm	80 mm
Safety circuit	550 °C (fixed)	550 °C (fixed)	550 °C (fixed)
Control accuracy with sensor	–	ETS-D5 / ± 0.5 K	ETS-D5 / ± 0.5 K
Heating plate material	ceramic	ceramic	ceramic
Set-up plate dimensions	100 x 100 mm	180 x 180 mm	260 x 260 mm
Weight	3 kg	5 kg	6 kg
Price	481.- EUR	510.- EUR 649.- EUR	724.- EUR
	Ident. No. 0003581000	Ident. No. 0003581200 C-MAG HS 7 Package Ident. No. 0009015900	Ident. No. 0003581400

	C-MAG HS 4 digital	C-MAG HS 7 digital	C-MAG HS 10 digital
Technical data			
Max. stirring quantity (H ₂ O)	5 l	10 l	15 l
Motor rating input / output	15 / 1.5 W	15 / 1.5 W	15 / 1.5 W
Speed range	100 – 1500 rpm	100 – 1500 rpm	100 – 1500 rpm
Heat output	250 W	1000 W	1500 W
Temperature range	50 – 500 °C	50 – 500 °C	50 – 500 °C
Display	LCD	LCD	LCD
Max. stirring bar length	30 mm	80 mm	80 mm
Adjustable safety circuit	550 °C (fixed)	550 °C (fixed)	550 °C (fixed)
Control accuracy with sensor	± 0.5 K	± 0.5 K	± 0.5 K
Heating plate material	ceramic	ceramic	ceramic
Set-up plate dimensions	100 x 100 mm	180 x 180 mm	260 x 260 mm
Weight	3 kg	5 kg	6 kg
Price	573.- EUR	637.- EUR	805.- EUR
	Ident. No. 0004240200*	Ident. No. 0003487000*	Ident. No. 0004240400*

* PT 1000.60 included in delivery

Package details on page 170

Accessories starting page 20 - 27

Multiposition Stirrers with / without heating

RT 15



Heating foil for homogeneous temperature distribution of the heating plate



Reverse rotation switch for better mixing results



Wear-free magnetic coils for consistent and silent operation



	RT 5	RT 10	RT 15
Technical data			
Number of stirring positions	5	10	15
Max. stirring quantity (H ₂ O) per position	0.4 l	0.4 l	0.4 l
Distance between stirring places	90 mm	90 mm	90 mm
Deviation for individual stirring positions	0%	0%	0%
Speed display	LED	LED	LED
Speed range	0 – 1000 rpm	0 – 1000 rpm	0 – 1000 rpm
Speed adjustment	10 rpm steps	10 rpm steps	10 rpm steps
Heat output	175 W	375 W	580 W
Temperature range heating plate	RT – 120 °C	RT – 120 °C	RT – 120 °C
Max. temperature medium (dep. on vessel)	70 °C	70 °C	70 °C
Set-up plate material	aluminum alloy	aluminum alloy	aluminum alloy
Set-up plate dimensions	110 x 495 mm	180 x 495 mm	270 x 495 mm
Dimensions (W x D x H)	120 x 610 x 60 mm	190 x 610 x 60 mm	280 x 610 x 60 mm
Weight	4 kg	7.5 kg	10.5 kg
Price	2,125.- EUR	2,844.- EUR	3,558.- EUR
	Ident. No. 0003690600	Ident. No. 0003691100	Ident. No. 0003692600



	RO 5	RO 10	RO 15
Technical data			
Number of stirring positions	5	10	15
Max. stirring quantity (H ₂ O) per position	0.4 l	0.4 l	0.4 l
Distance between stirring places	90 mm	90 mm	90 mm
Deviation for individual stirring positions	0%	0%	0%
Speed display	LED	LED	LED
Speed range	0 – 1200 rpm	0 – 1200 rpm	0 – 1200 rpm
Speed adjustment	10 rpm steps	10 rpm steps	10 rpm steps
Set-up plate material	stainless steel 1.4301	stainless steel 1.4301	stainless steel 1.4301
Set-up plate dimensions	120 x 470 mm	190 x 470 mm	280 x 470 mm
Dimensions (W x D x H)	120 x 570 x 60 mm	190 x 570 x 60 mm	280 x 570 x 60 mm
Weight	3 kg	5 kg	7 kg
Price	1,175.- EUR	1,300.- EUR	1,830.- EUR
	Ident. No. 0003690500	Ident. No. 0003691000	Ident. No. 0003692500

Magnetic Stirrers without heating

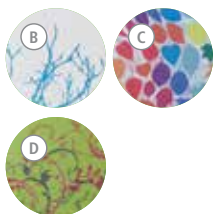

Technical data

	color squid	big squid
Max. stirring quantity (H ₂ O)	1 l	1.5 l
Motor rating input / output	3 / 2 W	3 / 2 W
Speed range	0 – 2500 rpm	0 – 2500 rpm
Speed display	LED	LED
Max. stirring bar length	30 mm	30 mm
Speed adjustment	50 rpm steps	50 rpm steps
Set-up plate material	glass	glass
Set-up plate dimensions	Ø 115 mm	Ø 160 mm
Dimensions (W x D x H)	145 x 160 x 45 mm	185 x 205 x 45 mm
Weight	0.54 kg	0.7 kg
Permissible ambient temperature	5 – 40 °C	5 – 40 °C
Permissible relative moisture	80%	80%
Protection class acc. to DIN EN 60529	IP 54	IP 54
Voltage	100 – 240 V	100 – 240 V
Frequency	50/60 Hz	50/60 Hz

Price **234,- EUR** **258,- EUR**

- | | |
|---|----------------------------------|
| (A) Ident. No. 0003671000 white | (A) Ident. No. 0003672000 white |
| (B) Ident. No. 0003698200 zebra | (B) Ident. No. 0003857200 frozen |
| (C) Ident. No. 0003698300 bubbles | (C) Ident. No. 0003857100 leaves |
| (D) Ident. No. 0003698400 wave | (D) Ident. No. 0003857300 twist |
| (E) Ident. No. 0004175500 seleção | |
| (F) Ident. No. 0004175300 solar sphere | |
| (G) Ident. No. 0004175100 stars and stripes | |
| (H) Ident. No. 0004175200 union Jack | |
| (I) Ident. No. 0004175400 red flag | |

Electronically controlled, high power motor for a higher capacity and higher speed range

Glass plate for excellent chemical resistance to acids, bases and solvents

The digital display enables precise setting of speed

color squid



color squid

- > For maximum stirring quantity of 1 l (H₂O)
- > Available in various interesting motives

big squid

- > For maximum stirring quantity of 1.5 l (H₂O)
- > Higher speed range from 0 – 2500 rpm

IKA®+

The difference between the color squid and the big squid is the **set-up plate diameter**.

color squid: Ø 115 mm
big squid: Ø 160 mm



Accessories starting page 20 - 27

Magnetic Stirrers without heating

NEW



IKA+

Mobile unit with rechargeable batteries with long operating time (8 – 12 h)

Technical data	Mini MR standard	topolino	topolino mobil
Max. stirring quantity (H ₂ O)	1 l	0.25 l	0.25 l
Motor rating input / output	3 / 2 W	1 / 0.8 W	1 / 0.8 W
Speed range	0 – 2500 rpm	300 – 1800 rpm	300 – 1800 rpm
Max. stirring bar length	30 mm	30 mm	30 mm
Speed adjustment	stepless	stepless	stepless
Set-up plate material	polyester	synthetic (PP)	synthetic (PP)
Set-up plate dimensions	115 x 115 mm	Ø 80 mm	Ø 80 mm
Dimensions (W x D x H)	115 x 129 x 37 mm	95 x 115 x 37 mm	Ø 140 x 42 mm
Weight	0.25 kg	0.32 kg	0.60 kg
Permissible ambient temperature	5 – 40 °C	5 – 40 °C	5 – 40 °C
Permissible relative moisture	80%	80%	80%
Protection class acc. to DIN EN 60529	IP 42	IP 21	IP 20
Voltage	100 – 240 V	100 – 240 V	100 – 240 V
Frequency	50/60 Hz	50/60 Hz	50/60 Hz
Price	199.- EUR	96.- EUR	200.- EUR
	Ident. No. 0025004132	Ident. No. 0003368000	Ident. No. 0003381300



Switchable reverse rotation every 30 seconds



Modern wear-free magnetic coil technology

lab disc



Ultra-flat for stirring quantities of up to 800 ml (H₂O)



lab disc
 > Set-up plate and casing made of chemically resistant materials
 > Slip-proof and safe stand

Height only
 12mm

lab disc
0.8 l
5 / 3 W
15 – 1500 rpm
25 mm
stepless
polyester
Ø 100 mm
117 x 180 x 12 mm
0.3 kg
5 – 40 °C
80%
IP 65
100 – 240 V
50/60 Hz
256.- EUR



- (A) Ident. No. 0003907500 white
- (B) Ident. No. 0003765000 pattern
- (C) Ident. No. 0003916100 stream

Magnetic Stirrers without heating

Maxi MR1 digital



For stirring quantities up to 150 l (H₂O)



Infinitely adjustable speed with digital display



Timer or continuous operation



Technical data	KMO 2 basic	Midi MR 1 digital	Maxi MR 1 digital
Max. stirring quantity (H ₂ O)	5 l	50 l	150 l
Motor rating input / output	14 / 4 W	70 / 19 W	80 / 35 W
Speed range	0 – 1100 rpm	0 – 1000 rpm	0 – 600 rpm
Speed display	scale	LCD	LCD
Max. stirring bar length	50 mm	80 mm	155 mm
Speed adjustment	stepless	stepless	stepless
Heating plate material	stainless steel 1.4301	stainless steel 1.4301	stainless steel 1.4301
Set-up plate dimensions	140 x 120 mm	350 x 350 mm	500 x 500 mm
Dimensions (W x D x H)	140 x 200 x 75 mm	360 x 430 x 110 mm	505 x 585 x 110 mm
Weight	1.4 kg	10.7 kg	16 kg
Permissible ambient temperature	5 – 40 °C	5 – 40 °C	5 – 40 °C
Permissible relative moisture	80%	80%	80%
Protection class acc. to DIN EN 60529	IP 21	IP 21	IP 21
Voltage	230 V	230 V	230 V
Frequency	50/60 Hz	50/60 Hz	50/60 Hz
Price	702.- EUR	2,805.- EUR	3,098.- EUR
	Ident. No. 0002812000	Ident. No. 0002621900	Ident. No. 0002621800

C-MAG MS 10



Ceramic set-up plate offers excellent chemical resistance to acid, bases and solvents



Powerful motor for stirring quantities up to 15 l (H₂O)



Elevated control panel for protection against spilled liquids



Technical data	C-MAG MS 4	C-MAG MS 7	C-MAG MS 10
Max. stirring quantity (H ₂ O)	5 l	10 l	15 l
Motor rating input / output	15 / 1.5 W	15 / 1.5 W	15 / 1.5 W
Speed range	100 – 1500 rpm	100 – 1500 rpm	100 – 1500 rpm
Speed display	scale	scale	scale
Max. stirring bar length	30 mm	80 mm	80 mm
Speed adjustment	scale (0 – 6)	scale (0 – 6)	scale (0 – 6)
Heating plate material	ceramic	ceramic	ceramic
Set-up plate dimensions	100 x 100 mm	180 x 180 mm	260 x 260 mm
Dimensions (W x D x H)	150 x 260 x 105 mm	220 x 330 x 105 mm	300 x 415 x 105 mm
Weight	3 kg	5 kg	6 kg
Permissible ambient temperature	5 – 40 °C	5 – 40 °C	5 – 40 °C
Permissible relative moisture	80%	80%	80%
Protection class acc. to DIN EN 60529	IP 21	IP 21	IP 21
Voltage	230 V	230 V	230 V
Frequency	50/60 Hz	50/60 Hz	50/60 Hz
Price	465.- EUR	543.- EUR	695.- EUR
	Ident. No. 0003582200	Ident. No. 0003582400	Ident. No. 0003582600

Accessories starting page 20 - 27

Magnetic Stirrers | Accessories

Electronic contact thermometers

	Ident. No.	Price
1 ETS-D5	0003378000	311.- EUR

Electronic contact thermometer, -50 – 450 °C, 0.1 K resolution

2 ETS-D6	0003378100	441.- EUR
----------	------------	-----------

Electronic contact thermometer. Similar to ETS-D5, additionally comes equipped with integrated pH measuring instrument (without pH electrode)

Temperature sensors for ETS-D5 / D6

	Ident. No.	Price
3 H 62.51	0002735451	158.- EUR

Temperature sensor, stainless steel

H 66.51	0002735551	236.- EUR
---------	------------	-----------

Temperature sensor, stainless steel glass-coated

H 66.53	0004499900	199.- EUR
---------	------------	-----------

Temperature sensor, coated with SafeCoat



ETS-D5 / D6 accessories

	Ident. No.	Price
4 H 70	0002735600	154.- EUR

Extension cable, 1 m

Temperature sensors for RCT / RET basic and C-MAG HS digital series

	Ident. No.	Price
5 PT 1000.60	0003516800	105.- EUR

Temperature sensor, stainless steel, Ø 3 mm, 230 mm length

6 PT 1000.70	0003736000	116.- EUR
--------------	------------	-----------

Temperature sensor, stainless steel, glass-coated, Ø 7 mm, 230 mm length

PT 1000.80	0004443000	112.- EUR
------------	------------	-----------

Temperature sensor, stainless steel, Ø 3 mm, 150 mm length

7 PT 1000.90	0004480600	149.- EUR
--------------	------------	-----------

Temperature sensor, stainless steel, coated with SafeCoat, Ø 3 mm, 230 mm length

Temperature sensors for RET® control-visc

	Ident. No.	Price
PT 100.51	0002600300	231.- EUR

Temperature sensor, stainless steel, glass-coated, Ø 8 mm, 230 mm length

8 PT 100.53	0004499700	236.- EUR
-------------	------------	-----------

Temperature sensor, stainless steel, coated with SafeCoat, Ø 3 mm, 230 mm length

PT 100.70	0020000440	101.- EUR
-----------	------------	-----------

Temperature sensor, stainless steel, Ø 3 mm, 230 mm length

PT 1000.50	0003367600	231.- EUR
------------	------------	-----------

Temperature sensor, dual, stainless steel, Ø 3 mm, 230 mm length

9 PT 1000.51	0003377700	268.- EUR
--------------	------------	-----------

Temperature sensor, dual, stainless steel, glass-coated, Ø 8 mm, 230 mm length



Temperature sensor	PT 100.51	PT 100.53	PT 100.70	PT 1000.50	PT 1000.51	PT 1000.53
Magnetic hotplate stirrer						
RH basic	<input type="checkbox"/>	<input type="checkbox"/>	<input type="checkbox"/>	<input type="checkbox"/>	<input type="checkbox"/>	<input type="checkbox"/>
RH digital	<input type="checkbox"/>	<input type="checkbox"/>	<input type="checkbox"/>	<input type="checkbox"/>	<input type="checkbox"/>	<input type="checkbox"/>
RCT basic	<input type="checkbox"/>	<input type="checkbox"/>	<input type="checkbox"/>	<input type="checkbox"/>	<input type="checkbox"/>	<input type="checkbox"/>
RET® basic	<input type="checkbox"/>	<input type="checkbox"/>	<input type="checkbox"/>	<input type="checkbox"/>	<input type="checkbox"/>	<input type="checkbox"/>
RET® control-visc	<input checked="" type="checkbox"/>	<input checked="" type="checkbox"/>	<input checked="" type="checkbox"/>	<input checked="" type="checkbox"/>	<input checked="" type="checkbox"/>	<input checked="" type="checkbox"/>
C-MAG HS/HP analog series	<input type="checkbox"/>	<input type="checkbox"/>	<input type="checkbox"/>	<input type="checkbox"/>	<input type="checkbox"/>	<input type="checkbox"/>
C-MAG HS digital series	<input type="checkbox"/>	<input type="checkbox"/>	<input type="checkbox"/>	<input type="checkbox"/>	<input type="checkbox"/>	<input type="checkbox"/>

Temperature sensor	PT 1000.60	PT 1000.70	PT 1000.80	PT 1000.90	ETS-D5	ETS-D6
Magnetic hotplate stirrer						
RH basic	<input type="checkbox"/>	<input type="checkbox"/>	<input type="checkbox"/>	<input type="checkbox"/>	<input checked="" type="checkbox"/>	<input checked="" type="checkbox"/>
RH digital	<input type="checkbox"/>	<input type="checkbox"/>	<input type="checkbox"/>	<input type="checkbox"/>	<input checked="" type="checkbox"/>	<input checked="" type="checkbox"/>
RCT basic	<input checked="" type="checkbox"/>	<input checked="" type="checkbox"/>	<input checked="" type="checkbox"/>	<input checked="" type="checkbox"/>	<input checked="" type="checkbox"/>	<input checked="" type="checkbox"/>
RET® basic	<input checked="" type="checkbox"/>	<input checked="" type="checkbox"/>	<input checked="" type="checkbox"/>	<input checked="" type="checkbox"/>	<input checked="" type="checkbox"/>	<input checked="" type="checkbox"/>
RET® control-visc	<input type="checkbox"/>	<input type="checkbox"/>	<input type="checkbox"/>	<input type="checkbox"/>	<input type="checkbox"/>	<input type="checkbox"/>
C-MAG HS/HP analog series*	<input type="checkbox"/>	<input type="checkbox"/>	<input type="checkbox"/>	<input type="checkbox"/>	<input checked="" type="checkbox"/>	<input checked="" type="checkbox"/>
C-MAG HS digital series	<input checked="" type="checkbox"/>	<input checked="" type="checkbox"/>	<input checked="" type="checkbox"/>	<input checked="" type="checkbox"/>	<input type="checkbox"/>	<input type="checkbox"/>

*Except C-MAG HS 4 /HP 4

Magnetic Stirrers | Accessories

Advantages beaker, stainless steel

- > No eddy current losses
- > High magnetic adhesion force
- > Very good heat transfer (3 L beaker and up: due to a round deepening area for fitting heating plates with Ø 135 mm)



Oil bath attachments

	Ident. No.	Price
① H 29	0002829400	175.- EUR
Oil bath attachment, 1 l, aluminum, inner Ø 136 – 180 mm, 81 mm height, for use with oil only		

H 30	0002829500	195.- EUR
------	------------	-----------

Oil bath attachment, 1.5 l, aluminum, inner Ø 136 – 190 mm, 110 mm height, for use with oil only

Beakers

② H 1000	0004444401	315.- EUR
Beaker, stainless steel, 1 l, inner Ø 160 mm, 79 mm height		

③ H 1500	0004444501	305.- EUR
Beaker, stainless steel, 1.5 l, inner Ø 140 mm, 160 mm height		

④ H 3000	0004444503	306.- EUR
Beaker, stainless steel, 3 l, inner Ø 180 mm, 119 mm height		

⑤ H 5000	0004444505	379.- EUR
Beaker, stainless steel, 5 l, inner Ø 220 mm, 142 mm height		

⑥ H 8000	0004444508	580.- EUR
Beaker, stainless steel, 8 l, inner Ø 265 mm, 162 mm height		

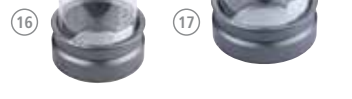

Protective covers

⑦ H 102	0004281600	14.- EUR
Cover for RH basic		
⑧ H 103	0004299100	14.- EUR
Cover for RH digital		
⑨ H 100	0003661000	14.- EUR
Cover for RET basic and RCT basic		
⑩ H 104	0004209500	14.- EUR
Cover for RET® control-visc		

Other accessories

H 11		
⑪ Euro plug	0001091500	25.- EUR
USA plug	0003564500	25.- EUR
UK plug	0002410700	25.- EUR
CH plug	0001091600	25.- EUR

Mains cable, spare

⑫ H 16 V	0001545100	54.- EUR
Support rod, Ø 10 mm, 450 mm length		

⑬ H 16.3	0025000622	14.- EUR
Extension for support rod		

⑭ H 44	0002437700	23.- EUR
Boss head clamp		

⑮ H 38	0003547700	23.- EUR
Holding rod		

⑯ HG 600	0020003416	108.- EUR
Heating jacket for beaker 600 ml		

⑰ HG 1000	0020003415	141.- EUR
Heating jacket for beaker 1000 ml		

⑱ BC 1000	0020003417	11.- EUR
Beaker cap		

C-MAG Adapter	0025001022	141.- EUR
Heating block adapter for C-MAG		

WICO RET control-visc	0020007259	518.- EUR
Wireless remote control		

Stirring bars

⑲ RS 1	0001358600	94.- EUR
--------	------------	----------

Consisting of IKAFLON® (10 – 80 mm) and TRIKA® (25 and 40 mm) magnetic stirring bars

⑳ RS 2	0004499100	107.- EUR
--------	------------	-----------

Consisting of IKAFLON® 40 round, 40 glass, 30 power, 40 slide round, 40 ellipse, 40 TRIKA®, 25 cross, 9 crown and 25 bone magnetic stirring bars

㉑ RSE	0001293100	59.- EUR
Stirring bar remover		

Magnetic Stirrers | Accessories

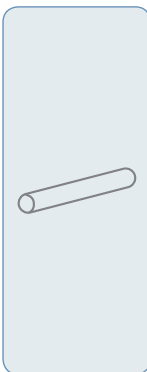

Stirring bars

IKAFLON® round

	Dimensions (L x Ø)	Ident. No.	Price
IKAFLON® 10 Set (5 Pcs) round PTFE-coated	10 x 6 mm	0004488600	7.- EUR
IKAFLON® 15 Set (5 Pcs) round PTFE-coated	15 x 6 mm	0004488700	8.- EUR
IKAFLON® 20 Set (5 Pcs) round PTFE-coated	20 x 8 mm	0004488800	9.- EUR
IKAFLON® 25 Set (5 Pcs) round PTFE-coated	25 x 8 mm	0004488900	11.- EUR
IKAFLON® 30 Set (5 Pcs) round PTFE-coated	30 x 8 mm	0004489000	11.- EUR
IKAFLON® 40 Set (5 Pcs) round PTFE-coated	40 x 8 mm	0004489100	12.- EUR
IKAFLON® 50 Set (5 Pcs) round PTFE-coated	50 x 8 mm	0004489200	13.- EUR
IKAFLON® 80 Set (5 Pcs) round PTFE-coated	80 x 10 mm	0004489300	31.- EUR
IKAFLON® 110 round PTFE-coated*	108 x 27 mm	0000793300	268.- EUR
IKAFLON® 155 round PTFE-coated*	153 x 27 mm	0001129000	358.- EUR

* Used for large magnetic stirrers like Maxi MR 1 digital

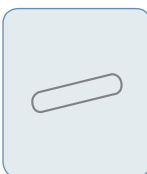

IKAFLON® glass round

	Dimensions (L x Ø)	Ident. No.	Price
IKAFLON® glass 25 Set (5 Pcs) round	25 x 6 mm	0004492200	17.- EUR
IKAFLON® glass 30 Set (5 Pcs) round	30 x 6 mm	0004492400	19.- EUR
IKAFLON® glass 40 Set (5 Pcs) round	45 x 8 mm	0004492600	21.- EUR
IKAFLON® glass 50 Set (5 Pcs) round	50 x 8 mm	0004492800	23.- EUR

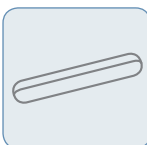

IKAFLON® power

	Dimensions (L x Ø)	Ident. No.	Price
IKAFLON® 20 Set (5 Pcs) power PTFE-coated	20 x 6 mm	0004493000	21.- EUR
IKAFLON® 30 Set (5 Pcs) power PTFE-coated	30 x 6 mm	0004493200	31.- EUR
IKAFLON® 50 Set (5 Pcs) power PTFE-coated	50 x 8 mm	0004493400	38.- EUR

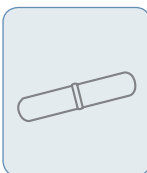

IKAFLON® slide round

	Dimensions (L x Ø)	Ident. No.	Price
IKAFLON® 25 Set (5 Pcs) slide round PTFE-coated	25 x 6 mm	0004493800	9.- EUR
IKAFLON® 30 Set (5 Pcs) slide round PTFE-coated	30 x 6 mm	0004494000	9.- EUR
IKAFLON® 40 Set (5 Pcs) slide round PTFE-coated	40 x 8 mm	0004494200	16.- EUR
IKAFLON® 50 Set (5 Pcs) slide round PTFE-coated	50 x 8 mm	0004494400	19.- EUR



IKAFLON® ellipse

	Dimensions (L x Ø)	Ident. No.	Price
IKAFLON® 20 Set (5 Pcs) ellipse PTFE-coated	20 x 10 mm	0004494600	14.- EUR
IKAFLON® 25 Set (5 Pcs) ellipse PTFE-coated	25 x 12 mm	0004494800	15.- EUR
IKAFLON® 30 Set (5 Pcs) ellipse PTFE-coated	32 x 16 mm	0004495000	20.- EUR
IKAFLON® 35 Set (5 Pcs) ellipse PTFE-coated	35 x 15 mm	0004495200	26.- EUR
IKAFLON® 40 Set (5 Pcs) ellipse PTFE-coated	40 x 20 mm	0004495400	33.- EUR
IKAFLON® 50 Set (5 Pcs) ellipse PTFE-coated	50 x 20 mm	0004495600	47.- EUR
IKAFLON® 60 Set (5 Pcs) ellipse PTFE-coated	64 x 20 mm	0004495800	69.- EUR
IKAFLON® 70 Set (5 Pcs) ellipse PTFE-coated	70 x 20 mm	0004496000	84.- EUR



IKAFLON® cross

	Dimensions (L x Ø)	Ident. No.	Price
IKAFLON® 10 Set (5 Pcs) cross PTFE-coated	10 x 10 mm	0004496200	12.- EUR
IKAFLON® 20 Set (5 Pcs) cross PTFE-coated	20 x 20 mm	0004496400	15.- EUR
IKAFLON® 25 Set (5 Pcs) cross PTFE-coated	25 x 25 mm	0004496600	18.- EUR
IKAFLON® 30 Set (5 Pcs) cross PTFE-coated	30 x 30 mm	0004496800	23.- EUR
IKAFLON® 38 Set (5 Pcs) cross PTFE-coated	38 x 38 mm	0004497000	29.- EUR

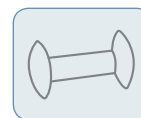

IKAFLON® bone

	Dimensions (L x Ø)	Ident. No.	Price
IKAFLON® 37 Set (5 Pcs) bone PTFE-coated	35 x 8 x 20 mm	0004497200	42.- EUR
IKAFLON® 54 Set (5 Pcs) bone PTFE-coated	55 x 8 x 20 mm	0004497400	51.- EUR

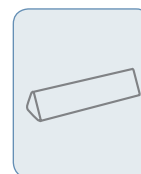

TRIKA®

	Dimensions (L x Ø)	Ident. No.	Price
TRIKA® 25 Set (5 Pcs) PTFE-coated	25 x 8 mm	0004499300	9.- EUR
TRIKA® 35 Set (5 Pcs) PTFE-coated	35 x 9 mm	0004499400	15.- EUR
TRIKA® 55 Set (5 Pcs) PTFE-coated	55 x 14 mm	0004499500	24.- EUR
TRIKA® 80 Set (5 Pcs) PTFE-coated	80 x 17 mm	0004499600	34.- EUR

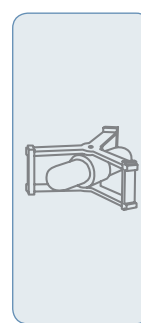

IKAFLON® beaker

	(Ø x Height in mm, for beaker)	Ident. No.	Price
IKAFLON® 67 beaker PTFE-coated	67 x 21 mm with 50 x 8	0004497600	240.- EUR
IKAFLON® 74 beaker PTFE-coated	74 x 29 mm with 60 x 9	0004497800	247.- EUR
IKAFLON® 103 beaker PTFE-coated	103 x 32 mm with 80 x 10	0004498000	357.- EUR
IKAFLON® 125 beaker PTFE-coated	125 x 48 mm with 106 x 25	0004498200	456.- EUR



IKAFLON® crown

	(Ø x Height in mm)	Ident. No.	Price
IKAFLON® 9 Set (5 Pcs) crown PTFE-coated	9 x 6 mm	0004498400	10.- EUR

* The admissible temperature range for PTFE-coated stirring bars is -200 – 280 ° C.

Magnetic Stirrers | Accessories

Synthesis blocks

Material: aluminum anodized



Dry heating block square series

	Hole Ø	Dimensions	Ident. No.	Price
① H 135.10 square carrier without handle	–	160 x 160 mm	0025000832	114.- EUR
② H 135.11 square carrier with handle	–	160 x 160 mm	0004448200	201.- EUR
H 135.101 block 16 x 4 ml	15.2 mm	79 x 79 mm	0025000626	42.- EUR
H 135.102 block 16 x 8 ml	17.5 mm	79 x 79 mm	0025000627	60.- EUR
③ H 135.103 block 9 x 16 ml	20.5 mm	79 x 79 mm	0025000628	46.- EUR
④ H 135.104 block 4 x 20 ml	28.5 mm	79 x 79 mm	0025000629	39.- EUR
H 135.105 block 4 x 30 ml	28.5 mm	79 x 79 mm	0025000630	46.- EUR
⑤ H 135.106 block 4 x 40 ml	28.5 mm	79 x 79 mm	0025000631	51.- EUR
H 135.107 block 100 ml	–	79 x 79 mm	0025000632	41.- EUR
⑥ H 135.108 block 250 ml	–	79 x 79 mm	0025000633	48.- EUR

100 ml flask heating block series

	Max. Outer Ø	Inner Ø	Ident. No.	Price
⑦ H 135.20 flask carrier 100 ml without handle	142 mm	–	0025000634	99.- EUR
⑧ H 135.21 flask carrier 100 ml with handle	142 mm	–	0004448300	185.- EUR
H 135.201 flask inlay 10 ml	–	33.8 mm	0025000636	23.- EUR
H 135.202 flask inlay 25 ml	–	43.8 mm	0025000637	23.- EUR
H 135.203 flask inlay 50 ml	–	52.8 mm	0025000638	23.- EUR



250 ml flask heating block series

	Max. Outer Ø	Inner Ø	Ident. No.	Price
⑨ H 135.25 flask carrier 250 ml without handle	142 mm	–	0025003280	120.- EUR
H 135.26 flask carrier 250 ml with handle	142 mm	–	0020007954	199.- EUR

500 ml flask heating block series

	Max. Outer Ø	Inner Ø	Ident. No.	Price
⑩ H 135.30 flask carrier 500 ml without handle	142 mm	–	0025000639	130.- EUR
⑪ H 135.31 flask carrier 500 ml with handle	142 mm	–	0004448400	210.- EUR
H 135.301 flask inlay 100 ml	–	66.3 mm	0025000641	52.- EUR
H 135.302 flask inlay 250 ml	–	88 mm	0025000642	54.- EUR

1000 ml flask heating block series

	Max. Outer Ø	Inner Ø	Ident. No.	Price
⑫ H 135.40 flask carrier 1000 ml without handle	166.3 mm	–	0025000833	166.- EUR
⑬ H 135.41 flask carrier 1000 ml with handle	166.3 mm	–	0004448500	279.- EUR
⑭ H 135.401 flask inlay 500 ml	–	108 mm	0025000644	94.- EUR

2000 ml flask heating block series

	Max. Outer Ø	Inner Ø	Ident. No.	Price
⑮ H 135.50 flask carrier 2000 ml without handle	194.7 mm	–	0025000834	204.- EUR
⑯ H 135.51 flask carrier 2000 ml with handle	194.7 mm	–	0004448600	390.- EUR
H 135.501 flask inlay 1000 ml	–	131.8 mm	0025000645	136.- EUR

Overhead Stirrers



The wireless controller

- > Helps protect the user from toxic fumes
- > Preserving sample integrity



EUROSTAR 100 control



Wireless Controller (WiCo)
Removable wireless controller for easy and user-friendly operation



USB interface to control and document rheological changes and other parameters using labworldsoft® software and for updating your firmware



Brushless EC motor for longer life span, low maintenance and higher efficiency

IKA® offers overhead stirrers for your stirring and mixing tasks in the lab – for low to high viscosities. Safety, power and intelligence are the core of this product range. IKA® overhead mixers process stirring quantities of up to 200 liters.

Electronic Overhead Stirrers



Rotating knob for adjusting the speed and pressing knob



Digital display for precise monitoring of set and actual speeds



Wireless Controller (WiCo)
Removable wireless controller for easy and user-friendly operation



USB interface to control and document rheological changes and other parameters using labworldsoft® software and for updating your firmware



Brushless EC motor for longer life span, low maintenance and higher efficiency



External probe for accurate temperature control



Technical data

Stirring quantity max. (H ₂ O)
Max. viscosity
Motor rating input / output
Speed range
Max. torque at stirring shaft
Temp. sensor connection
Chuck range
Dimensions (W x D x H)
Weight
Permissible ambient temp.
Permissible relative moisture
Protection class DIN EN 60529

EUROSTAR 20 digital

replaces RW 14 EUROSTAR digital
15 l
10,000 mPas
70 / 42 W
0/30 – 2000 rpm
20 Ncm
no
0.5 – 10 mm
86 x 208 x 248 mm
4.4 kg
5 – 40 °C
80%
IP 40

860.- EUR

Ident. No. 0004442000

EUROSTAR 40 digital

replaces RW 16 EUROSTAR digital
25 l
30,000 mPas
118 / 84 W
0/30 – 2000 rpm
40 Ncm
no
0.5 – 10 mm
86 x 208 x 248 mm
4.4 kg
5 – 40 °C
80%
IP 40

1,100.- EUR

Ident. No. 0004444000

Technical data

Stirring quantity max. (H ₂ O)
Max. viscosity
Motor rating input / output
Speed range
Max. torque at stirring shaft
Temp. sensor connection
Chuck range
Dimensions (W x D x H)
Weight
Permissible ambient temp.
Permissible relative moisture
Protection class DIN EN 60529

EUROSTAR 60 digital | control

replaces EUROSTAR power basic; EUROSTAR power control-visc
40 l
50,000 mPas
176 / 126 W 168 / 131 W
0/30 – 2000 rpm
60 Ncm
no PT 1000
0.5 – 10 mm
86 x 208 x 248 mm 86 x 230 x 267 mm
4.4 kg 4.7 kg
5 – 40 °C
80%
IP 40

1,220.- EUR | 1,691.- EUR

Ident. No. 0004446000
Ident. No. 0004440000*

EUROSTAR 100 digital | control

replaces EUROSTAR control-visc P1
100 l
70,000 mPas
186 / 136 W 174 / 142 W
0/30 – 1300 rpm
100 Ncm
no PT 1000
0.5 – 10 mm
86 x 208 x 248 mm 86 x 230 x 267 mm
4.4 kg 4.7 kg
5 – 40 °C
80%
IP 40

1,797.- EUR | 2,156.- EUR

Ident. No. 0004238100
Ident. No. 0004028500*

* H 67.60 temperature sensor and WH 11 WiCo holder included in the delivery of all EUROSTAR control devices

Accessories starting page 36 - 41

Electronic Overhead Stirrers



Watch the video now:
www.ika.com/video



	EUROSTAR 200 digital control	EUROSTAR 400 digital control
Technical data	replaces EUROSTAR control-visc P4	
Stirring quantity max. (H ₂ O)	100 l	150 l
Max. viscosity	100,000 mPas	100,000 mPas
Motor rating input / output	130 / 84 W	220 / 176 W
Speed range	0/6 – 2000 rpm	0/6 – 2000 rpm
Max. torque at stirring shaft	200 Ncm	400 Ncm
Temp. sensor connection	no PT 1000	no PT 1000
Chuck range	0.5 – 10 mm	0.5 – 10 mm
Dimensions (W x D x H)	91 x 209 x 274 mm 91 x 231 x 297 mm	114 x 245 x 300 mm 114 x 268 x 320 mm
Weight	4.6 kg 4.9 kg	7.8 kg 8.2 kg
Permissible ambient temp.	5 – 40 °C	5 – 40 °C
Permissible relative moisture	80%	80%
Protection class DIN EN 60529	IP 40	IP 40
Price	2,253.- EUR 2,542.- EUR	2,700.- EUR 3,115.- EUR
	Ident. No. 0003990000 Ident. No. 0003992000*	Ident. No. 0004214000 Ident. No. 0004214100*



	EUROSTAR 20 high speed digital control	EUROSTAR 200 control P4
Technical data	replaces EUROSTAR power control-visc 6000	replaces EUROSTAR control-visc P7
Stirring quantity max. (H ₂ O)	20 l	100 l
Max. viscosity	10,000 mPas	150,000 mPas
Motor rating input / output	176 / 125 W	134 / 76 W
Speed range	0/150 – 6000 rpm	0/4 – 530 rpm
Max. torque at stirring shaft	20 Ncm	660 Ncm
Temp. sensor connection	no PT 1000	PT 1000
Chuck range	fixed	0.5 – 10 mm
Dimensions (W x D x H)	86 x 208 x 325 mm 86 x 230 x 325 mm	91 x 231 x 379 mm
Weight	5.3 kg 4.7 kg	5.8 kg
Permissible ambient temp.	5 – 40 °C	5 – 40 °C
Permissible relative moisture	80%	80%
Protection class DIN EN 60529	IP 40	IP 40
Price	1,603.- EUR 2,138.- EUR	3,448.- EUR
	Ident. No. 0004028600 Ident. No. 0025001314*	Ident. No. 0004090000*

* H 67.60 temperature sensor and WH 11 WiCo holder included in the delivery of all EUROSTAR control devices

Accessories starting page 36 - 41

Mechanical Overhead Stirrers



Technical data

Stirring quantity max. (H ₂ O)	20 l
Max. viscosity	10,000 mPas
Motor rating input/output	70 / 35 W
Permissible ON time	100%
Speed range	60 – 2000 rpm (50 Hz)
Max. torque at stirring shaft	150 Ncm
Display	LED
Temp. sensor connection	no
Chuck range	0.5 – 10 mm
Hollow shaft	yes
Dimensions (W x D x H)	88 x 212 x 294 mm
Weight	3.1 kg
Permissible ambient temp.	5 – 40 °C
Permissible relative moisture	80%
Protection class DIN EN 60529	IP 20

Price 998.- EUR

Ident. No. 0003593000

RW 20 digital

Technical data

Stirring quantity max. (H ₂ O)	80 l
Max. viscosity	50,000 mPas
Motor rating input/output	220 / 90 W
Permissible ON time	100%
Speed range	60 – 1400 rpm (50 Hz)
Max. torque at stirring shaft	900 Ncm
Display	LED
Temp. sensor connection	no
Chuck range	1 – 10 mm
Hollow shaft	yes
Dimensions (W x D x H)	123 x 252 x 364 mm
Weight	7.5 kg
Permissible ambient temp.	5 – 40 °C
Permissible relative moisture	80%
Protection class DIN EN 60529	IP 40

Price 2,589.- EUR | 3,279.- EUR

Ident. No. 0005040000

[RW 28 digital Package](#)

Ident. No. 0009023200

RW 28 digital

replaces RW 28 basic

RW 47 digital

replaces RW 47 D

Stirring quantity max. (H ₂ O)	200 l
Max. viscosity	100,000 mPas
Motor rating input/output	513 / 370 W
Permissible ON time	100%
Speed range	57 – 1300 rpm (50 Hz)
Max. torque at stirring shaft	3000 Ncm
Display	LED
Temp. sensor connection	no
Chuck range	3 – 16 mm
Hollow shaft	no
Dimensions (W x D x H)	145 x 358 x 465 mm
Weight	16 kg
Permissible ambient temp.	5 – 40 °C
Permissible relative moisture	80%
Protection class DIN EN 60529	IP 54

Price 4,700.- EUR | 5,608.- EUR

Ident. No. 0004050000

[RW 47 digital Package](#)

Ident. No. 0009023300

Package details on page 170
Accessories starting page 36 - 41

Overhead Stirrers | Accessories



Propeller stirrer, 4-bladed

Standard stirring element for drawing the material to be mixed from the top to the bottom. It creates local shearing forces and axial flow in the vessel. This propeller stirrer is used at medium to high speeds.

Name	R 1342	R 1345	R 2302
Ident. No.	0000741000	0000741300	0000739000
Stirrer (Ø)	50 mm	100 mm	150 mm
Shaft (Ø)	8 mm	8 mm	13 mm
Shaft length	350 mm	540 mm	800 mm
Price	121.- EUR	147.- EUR	521.- EUR
	(A B C) (D E G)	(A B C) (D E G) (H)	(I)



Propeller stirrer, 3-bladed

Flow-efficient design for drawing the material to be mixed from the top and the bottom while creating minimum shearing forces. This propeller stirrer is used at medium to high speeds.

Name	R 1381	R 1382
Ident. No.	0001296000	0001295900
Stirrer (Ø)	45 mm	55 mm
Shaft (Ø)	8 mm	8 mm
Shaft length	350 mm	350 mm
Price	241.- EUR	254.- EUR
	(A B C) (D E)	(A B C) (D E)

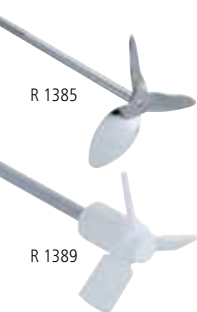

Propeller stirrer, 3-bladed

Flow-efficient design for drawing the material to be mixed from the top and the bottom while creating minimum shearing forces. This propeller stirrer is used at medium to high speeds.

Name	R 1385	R 1388	R 1389 (PTFE-coated)
Ident. No.	0000477700	0000477800	0002343600
Stirrer (Ø)	140 mm	140 mm	75 mm
Shaft (Ø)	10 mm	10 mm	8 mm
Shaft length	550 mm	800 mm	350 mm
Price	238.- EUR	291.- EUR	442.- EUR
	(A B C) (D E G) (H)	(A B C) (D E G) (H)	(A B C)



Turbine stirrer

This stirrer is used for drawing the material to be mixed from above while generating axial flow within the vessel. It carries a minimum level of danger of injury when contact is made with vessel. It also creates minimum shearing forces and is used at medium to high speeds.

Name	R 1311	R 1312	R 1313
Ident. No.	0002332900	0002333000	0002333100
Stirrer (Ø)	30 mm	50 mm	70 mm
Shaft (Ø)	8 mm	8 mm	10 mm
Shaft length	350 mm	350 mm	400 mm
Price	152.- EUR	197.- EUR	251.- EUR
	(A B C) (D E G)	(A B C) (D E G)	(A B C) (D E G)



Centrifugal stirrer

Two-bladed stirrer who's blades open with increasing speed. Perfect for stirring in round vessels with narrow necks and the effect is similar to that of a 4-bladed propeller stirrer. Medium to high speeds required.

Name	R 1352	R 1355
Ident. No.	0000756900	0001132700
Stirrer (Ø)	60 / 15 mm	100 / 24 mm
Shaft (Ø)	8 mm	8 mm
Shaft length	350 mm	550 mm
Price	129.- EUR	171.- EUR
	(A B C) (D E G)	(A B C) (D E G)

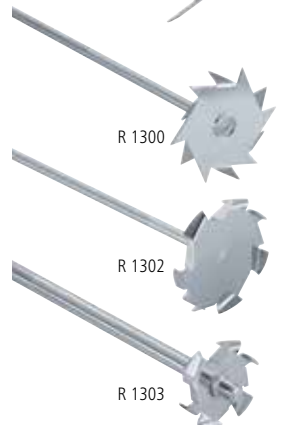

Dissolver stirrer

This stirrer provides radial flow for drawing the material to be mixed from the top and the bottom while creating high turbulence and high shearing forces for particle reduction. Medium to high speeds required.

Name	R 1300	R 1302	R 1303
Ident. No.	0000513500	0002387900	0002746700
Stirrer (Ø)	80 mm	100 mm	42 mm
Shaft (Ø)	8 mm	10 mm	8 mm
Shaft length	350 mm	350 mm	350 mm
Price	214.- EUR	464.- EUR	353.- EUR
	(A B C) (D E G) (H)	(A B C) (D E G) (H)	(A B C) (D E G) (H)



EUROSTAR 20 | 40 digital

(A)



EUROSTAR 60 digital | control

(B)



EUROSTAR 100 digital | control

(C)



EUROSTAR 200 digital | control

(D)



EUROSTAR 400 digital | control



EUROSTAR 200 control P4

(E)



EUROSTAR 20 high speed digital | control

(F)



RW 20 digital

(G)



RW 28 digital

(H)



RW 47 digital

(I)

Overhead Stirrers | Accessories

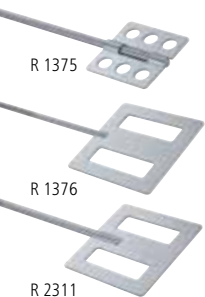

Paddle stirrer

This stirrer creates tangential flow, minimum turbulence, good heat exchange and gentle treatment of the product. Low to medium speeds required.

Name	R 1375	R 1376	R 2311
Ident. No.	0000757700	0000757800	0000739500
Stirrer (∅)	70 mm	150 mm	150 mm
Shaft (∅)	8 mm	10 mm	13 mm
Shaft length	550 mm	550 mm	800 mm
Price	139.- EUR	289.- EUR	497.- EUR
	(A)(B)(C) (D)(E)(G)	(B)(C)(D) (E)(G)(H)	(I)

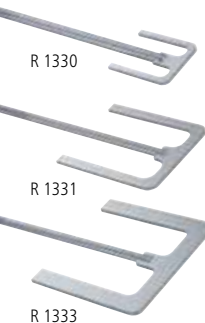

Anchor stirrer

This stirrer creates tangential flow, high shearing rate at the edges, minimum deposits on the vessel wall making them great for polymer reactions and even distribution of high mineral contents in liquids. Ideal for medium to highly viscous fluids. Low speeds required.

Name	R 1330	R 1331	R 1333
Ident. No.	0002022300	0002022400	0002747400
Stirrer (∅)	45 mm	90 mm	150 mm
Shaft (∅)	8 mm	8 mm	10 mm
Shaft length	350 mm	350 mm	550 mm
Price	303.- EUR	338.- EUR	618.- EUR
	(A)(B)(C) (D)(E)(G)	(A)(B)(C) (D)(E)(G) (H)	(B)(C)(D) (E)(G)(H)



Moebius stirrer

Generates axial flow. For drawing the material to be mixed from above. For circulating and handling low to medium viscous liquids. Used at medium speeds.

Name	R 3000.1	R 3001.1
Ident. No.	0020001192	0020001195
Stirrer (∅)	100 mm	100 mm
Shaft (∅)	10 mm	10 mm
Shaft length	565 mm	575 mm
Price	328.- EUR	328.- EUR
	(A)(B)(C) (D)(E)(G)	(A)(B)(C) (D)(E)(G)

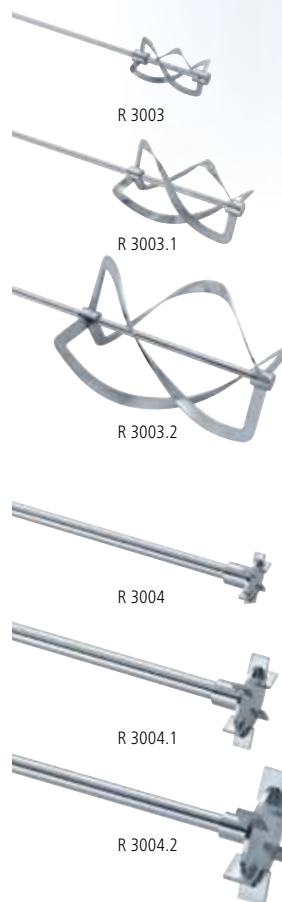

Spiral stirrer

Generates axial flow. Medium is conveyed from the bottom upwards. For homogeneous mixing and heat exchange of medium to high viscosity media. Used at low to medium speeds.

Name	R 3003	R 3003.1	R 3003.2
Ident. No.	0020001203	0020001204	0020001205
Stirrer (∅)	50 mm	100 mm	150 mm
Shaft (∅)	8 mm	10 mm	10 mm
Shaft length	350 mm	550 mm	800 mm
Price	273.- EUR	383.- EUR	493.- EUR
	(A)(B)(C) (D)(E)(G)	(A)(B)(C) (D)(E)(G)	(A)(B)(C) (D)(E)(G) (I)

Blade stirrer

Generates a radial flow. For drawing the material to be mixed from the top and bottom. For aerating of low viscosity media and for homogenizing solids in liquids. Used at medium to high speeds.

Name	R 3004	R 3004.1	R 3004.2
Ident. No.	0020001206	0020001207	0020001208
Stirrer (∅)	30 mm	50 mm	70 mm
Shaft (∅)	8 mm	8 mm	10 mm
Shaft length	359 mm	565 mm	819 mm
Price	230.- EUR	328.- EUR	438.- EUR
	(A)(B)(G)	(A)(B)(G)	(A)(B)(C) (D)(E)(G)



EUROSTAR 20 | 40 digital

(A)



EUROSTAR 60 digital | control

(B)



EUROSTAR 100 digital | control

(C)



EUROSTAR 200 digital | control

(D)



EUROSTAR 400 digital | control



EUROSTAR 200 control P4

(E)



EUROSTAR 20 high speed digital | control

(F)



RW 20 digital

(G)



RW 28 digital

(H)



RW 47 digital

(I)

Overhead Stirrers | Accessories

EUROSTAR 20 high speed digital | control accessories

	Ident. No.	Price
1 R 1401	0001242900	207.- EUR
Propeller blade, Ø 55 mm		
2 R 1402	0001243300	228.- EUR
Dissolver, Ø 42 mm		
3 R 1405	0001289800	167.- EUR
Propeller blade, Ø 45 mm		

RW 47 digital accessories

	Ident. No.	Price
4 R 303	0030000257	343.- EUR
Stirring shaft protection for RW 47 digital		
5 SI 400	0003294800	760.- EUR
Safety switch		
6 SI 472	0003264000	713.- EUR
Fixing device for R 472 stand		
7 SI 474	0003264400	318.- EUR
Fixing device for R 474 and T 653 stand		

RW 20 digital & EUROSTAR series accessories

	Ident. No.	Price
8 FK 1	0002336000	254.- EUR
Flexible coupling, clamping range 6 – 10 mm		
9 R 60	0003889500	77.- EUR
Keyless chuck for EUROSTAR 20 / 40 / 60 / 100 series		
10 R 301	0002603000	134.- EUR
Stirring shaft protection, plexiglass		
11 R 301.1	0002604000	166.- EUR
Support holder for R 301		

EUROSTAR control series accessories

	Ident. No.	Price
12 H 66.51*	0002735551	236.- EUR
Temperature sensor, stainless steel, glass-coated, Ø 6 mm, 260 mm length		
H 66.53*	0004499900	199.- EUR
Temperature sensor, coated with SafeCoat, Ø 3 mm, 260 mm length		
H 67.60*	0025000215	108.- EUR
Temperature sensor, stainless steel, Ø 3 mm		
H 67.61*	0020003865	163.- EUR
Temperature sensor, stainless steel, Ø 3 mm, response time 0.9 = 4 s		
13 H 70	0002735600	154.- EUR
Extension cable, 1 m		
WH 11	0025001500	20.- EUR
Wall mount for WiCo		
labworldsoft®	0004720000	1,212.- EUR
Laboratory software		

* For using the temperature sensors, H 70 cable is required



Shakers



IKA® offers a wide range of lab shakers for mixing and shaking applications. Products are equipped with digital display, timer function, and controlling options via the lab software labworldsoft®. Integrated end point positioning allows for automated sampling. An extensive array of attachments is available for the use of different vessels.



Versatile and adjustable vortex mixer

- > Compact design
- > Various applications easily interchangeable with our attachments and inserts (e.g. Eppendorf tubes, microtiter plates, Erlenmeyer flasks etc.)



Vortex 2



Continuous or touch operation



Wide speed range enables intensive mixing, even for small vessels



Orbital action

Shakers

MS 3 digital



Orbital action



Wide range of attachments



Continuous or touch operation



NEW



HANDS FOR CHILDREN
by IKA



Orbital action



Wide speed range enables intensive mixing, even for small vessels



Different applications easily handled with interchangeable attachments and inserts

Vortex 3



Technical data	lab dancer	Vortex 1	Vortex 2
Type of movement	orbital	orbital	orbital
Shaking diameter	4.5 mm	4.5 mm	4 mm
Permissible shaking weight (incl. attachment)	max. 50 ml (1 test tube)	0.1 kg	0.4 kg
Motor rating input / output	1.2 / 0.8 W	1.2 / 0.8 W	39 / 9 W
Speed range	2800 rpm (fixed)	1000 – 2800 rpm	500 – 2500 rpm
Speed display	none	none	scale (0 – 6)
Timer display	none	none	none
Operating mode	touch operation	touch operation	continuous operation / touch operation
Dimensions (W x D x H)	100 x 70 mm (Ø x H)	95 x 110 x 70 mm	120 x 138 x 140 mm
Weight	0.55 kg	0.55 kg	3.9 kg
Permissible ambient temp.	5 – 40 °C	5 – 40 °C	5 – 40 °C
Permissible relative moisture	80%	80%	80%
Price	243.- EUR	262.- EUR	206.- EUR
	Ident. No. 0003365000	Ident. No. 0004047700	Ident. No. 0025000258

Technical data	Vortex 3	MS 3 basic digital	Vortex 4 basic digital
Type of movement	orbital	orbital	orbital
Shaking diameter	4 mm	4.5 mm	4.5 mm
Permissible shaking weight (incl. attachment)	0.4 kg	0.5 kg	0.5 kg
Motor rating input / output	58 / 10 W	10 / 8 W	10 / 8 W
Speed range	500 – 2500 rpm	200 – 3000 rpm	200 – 3000 rpm
Speed display	scale (0 – 6)	scale	scale
Timer display	none	none digital	none digital
Operating mode	continuous / touch operation	continuous / touch operation timer and continuous / touch operation	continuous / touch operation timer and continuous / touch operation
Dimensions (W x D x H)	127 x 149 x 136 mm	148 x 205 x 63 mm	176 x 190 x 63 mm
Weight	4.5 kg	2.9 kg	3 kg
Permissible ambient temp.	5 – 40 °C	5 – 40 °C	5 – 40 °C
Permissible relative moisture	80%	80%	80%
Price	347.- EUR	502.- EUR 689.- EUR	359.- EUR 438.- EUR
	Ident. No. 0003340000	Ident. No. 0003617000 Ident. No. 0003319000	Ident. No. 0004049600 Ident. No. 0004050100

Shakers



Technical data	VXR basic	MTS 2/4 digital Microtiter shaker
Type of movement	orbital	orbital
Shaking diameter	4 mm	3 mm
Permissible shaking weight (incl. attachment)	2 kg	2 or 4 microtiter plates (MTP)
Motor rating input / output	35 / 13.2 W	35 / 13.2 W
Speed range	0 – 2200 rpm	0 – 1100 rpm
Speed display	scale	scale
Timer display	none	∞ / 1 – 99 min
Operating mode	continuous operation	timer and continuous operation
Dimensions (W x D x H)	157 x 247 x 130 mm	185 x 320 x 105 mm
Weight	6.1 kg	2.7 kg
Permissible ambient temp.	5 – 40 °C	5 – 40 °C
Permissible relative moisture	80%	80%
Price	1,285.- EUR	1,374.- EUR
	Ident. No. 0002819000	Ident. No. 0003208000

Accessories starting page 56 - 63



Shakers

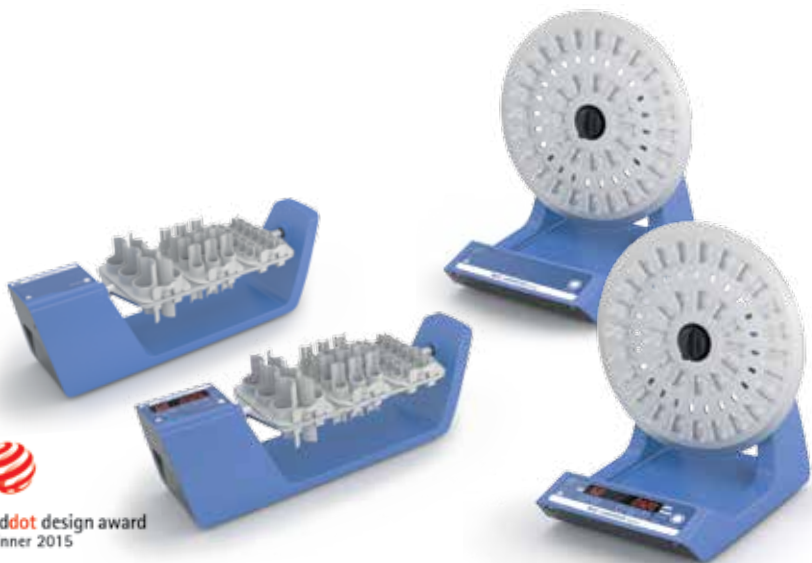

 **reddot design award**
winner 2015

Technical data	Trayster basic digital	Loopster basic digital
Type of movement	rotating	rotating
Permissible shaking weight (incl. attachment)	2 kg	2 kg
Motor rating input / output	16 / 9 W	16 / 9 W
Speed range	20 rpm (fixed) 5 – 80 rpm	20 rpm (fixed) 5 – 80 rpm
Speed display	none 7 segment LED	none 7 segment LED
Timer	no ∞ / 1 s – 99.9 h	no ∞ / 1 s – 99.9 h
Timer display	none 7 segment LED	none 7 segment LED
Dimensions (W x D x H)	460 x 140 x 180 mm	300 x 300 x 360 mm
Weight	1.6 kg	3 kg
Price	622.- EUR 789.- EUR	598.- EUR 686.- EUR
	Ident. No. 0004005000* Ident. No. 0004006000*	Ident. No. 0004015000* Ident. No. 0004016000*



 **Loopster digital**

 Choice of tube holders to hold a number of different sized tubes

 90 degree adjustable mixing angle



 Touch keypad for easy operation

 Rotating action

 **Timer Display** for accurate and reproducible conditions

* Loopster and Trayster accessories have to be ordered separately

Shakers



Technical data	Rocker 2D basic digital	Rocker 3D basic digital
Type of movement	rocking	tumbling
Shaking diameter	8° (angle) 2.5 – 15° (angle)	8° (angle) 0 – 15° (angle)
Permissible shaking weight (incl. attachment)	2 kg	2 kg
Motor rating input / output	16 / 9 W	16 / 9 W
Speed range	5 – 80 rpm	30 rpm (fixed) 5 – 80 rpm
Speed display	7 segment LED	none 7 segment LED
Timer	no ∞ / 1 s – 99.9 h	no ∞ / 1 s – 99.9 h
Timer display	none 7 segment LED	none 7 segment LED
Dimensions (W x D x H)	280 x 330 x 150 mm	280 x 330 x 165 mm 280 x 330 x 185 mm
Weight	2.2 kg	2.2 kg 2.3 kg
Price	628.- EUR 708.- EUR	758.- EUR 837.- EUR
	Ident. No. 0004002000* Ident. No. 0004003000*	Ident. No. 0004000000* Ident. No. 0004001000*

* RD 1 universal mat included in the delivery of all Rockers

Roller 6 digital



Touch keypad for easy operation

Timer Display

Timer display for accurate and reproducible conditions



CT button for choosing the counter or the timer function

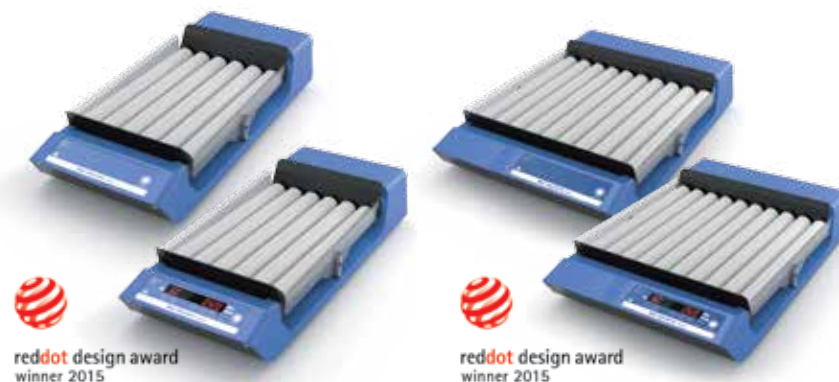

Technical data	Roller 6 basic digital	Roller 10 basic digital
Type of movement	rocking and rolling	rocking and rolling
Shaking diameter	24.5 mm (high)	24.5 mm (high)
Permissible shaking weight (incl. attachment)	2 kg	2 kg
Motor rating input / output	16 / 9 W	16 / 9 W
Speed range	30 rpm (fixed) 5 – 80 rpm	30 rpm (fixed) 5 – 80 rpm
Speed display	none 7 segment LED	none 7 segment LED
Timer	no ∞ / 1 s – 99.9 h	no ∞ / 1 s – 99.9 h
Timer display	none 7 segment LED	none 7 segment LED
Dimensions (W x D x H)	240 x 545 x 115 mm	380 x 545 x 115 mm
Weight	4 kg	6 kg
Price	1,210.- EUR 1,363.- EUR	1,502.- EUR 1,653.- EUR
	Ident. No. 0004010000 Ident. No. 0004011000	Ident. No. 0004012000 Ident. No. 0004013000

Accessories starting page 56 - 63

Shakers



	KS 130 basic control (NOL*)	HS 260 basic control (NOL*)	HS 501 digital
Technical data		*No end-point positioning	
Type of movement	orbital	reciprocating	reciprocating
Shaking diameter	4 mm	20 mm	30 mm
Permissible shaking weight (incl. attachment)	2 kg	7.5 kg	15 kg
Motor rating input / output	45 / 10 W	45 / 10 W	70 / 19 W
Permissible ON time	100 %	100 %	100 %
Speed range	0 – 800 rpm	0 – 300 rpm 10 – 300 rpm	0 – 300 rpm
Speed display	LED line digital	LED line digital	digital
Timer	∞ / 5 – 50 min ∞ / 0 – 9 h 59 min	∞ / 5 – 50 min ∞ / 0 – 9 h 59 min	∞ / 1 – 56 min
Operating mode	timer and continuous operation	timer and continuous operation	timer and continuous operation
Dimensions (W x D x H)	270 x 316 x 98 mm	360 x 420 x 100 mm	505 x 585 x 120 mm
Weight	8.8 kg	8.5 kg 8.8 kg	26 kg
Permissible ambient temp.	5 – 50 °C	5 – 50 °C	5 – 50 °C
Permissible relative moisture	80%	80%	80%
Price	1,360.- EUR 2,046.- EUR 1,589.- EUR	2,170.- EUR 2,832.- EUR 2,278.- EUR	4,207.- EUR
	KS 130 basic Ident. No. 0002980000	HS 260 basic Ident. No. 0003066600	Ident. No. 0002527000
	KS 130 control Ident. No. 0002980100	HS 260 control Ident. No. 0003066700	
	KS 130 control NOL* Ident. No. 0004278200	HS 260 control NOL* Ident. No. 0004278600	



Wide range of attachment combinations



Orbital action



Digital display allows reading of speed, timer function and operating modes



All functions can be controlled and documented with labworldsoft®



KS 260 control



	KS 260 basic KS 260 control KS 260 control (NOL*)	KS 501 digital
Technical data	*No end-point positioning	
Type of movement	orbital	orbital
Shaking diameter	10 mm	30 mm
Permissible shaking weight (incl. attachment)	7.5 kg	15 kg
Motor rating input / output	45 / 10 W	70 / 19 W
Permissible ON time	100%	100%
Speed range	50 – 500 rpm 10 – 500 rpm	0 – 300 rpm
Speed display	LED line digital	digital
Timer	∞ / 5 – 50 min ∞ / 0 – 9 h 59 min	∞ / 1 – 56 min
Timer display	LED line digital	digital
Operating mode	timer and continuous operation	timer and continuous operation
Dimensions (W x D x H)	360 x 420 x 98 mm	505 x 585 x 120 mm
Weight	8.5 kg 8.8 kg	26 kg
Permissible ambient temp.	5 – 50 °C	5 – 50 °C
Permissible relative moisture	80%	80%
Price	2,170.- EUR 2,832.- EUR 2,325.- EUR	4,207.- EUR
	KS 260 basic Ident. No. 0002980200	Ident. No. 0002526400
	KS 260 control Ident. No. 0002980300	
	KS 260 control NOL* Ident. No. 0004278400	

Package details on page 171
Accessories starting page 56 - 63

Incubator Shakers

 KS 3000
ic control

 KS 4000
ic control

 Assure highly accurate
temperature control

Orbital action

Technical data

	KS 3000 i control ic control	KS 4000 i control ic control
Type of movement	orbital	orbital
Shaking diameter	20 mm	20 mm
Permissible shaking weight (incl. attachment)	7.5 kg	20 kg
Motor rating input / output	45 / 10 W	82 / 24 W
Permissible ON time	100%	100%
Speed range	10 – 500 rpm	10 – 500 rpm
Heating temperature range	RT +5 °C – 80 °C RT -10 °C – 80 °C	RT +5 °C – 80 °C RT -10 °C – 80 °C
Timer	1 s – 999 h	1 s – 999 h
Timer display	LED	LED
Operating mode	timer and continuous operation	timer and continuous operation
Dimensions (W x D x H)	465 x 695 x 430 mm	580 x 750 x 525 mm
Weight	35 kg 37 kg	50 kg 55 kg
Permissible ambient temp.	15 – 32 °C	15 – 32 °C
Permissible relative moisture	80%	80%
Built-in cooling coil	no yes	no yes

Price

4,695.- EUR | 5,761.- EUR

 Ident. No. 0003940000
Ident. No. 0003940100

5,745.- EUR | 6,915.- EUR

 Ident. No. 0003510000
Ident. No. 0003510100

 Built-in cooling coil for connection
to an external cooling unit
(available only for KS 3000 ic
/ KS 4000 ic control)

 Wide range of attachments
allows using almost all
shapes and sizes of vessels

 USB interface to control and
document all parameters using
labworldsoft® software and for
updating your firmware

Shakers | Accessories



Vortex 2 / Vortex 3 accessories

	Ident. No.	Price
1 VG 3.1 Standard attachment	0003341200	9.- EUR
2 VG 3.2 One-hand attachment, 88 mm	0003342300	18.- EUR
3 VG 3.3 Universal attachment, 150 mm	0003342400	20.- EUR
4 VG 3.31* Test tube attachment for 54 Eppendorf tubes	0003344300	55.- EUR
5 VG 3.32* Test tube attachment, 18 x Ø 10 mm	0003343900	28.- EUR

6 VG 3.33* Test tube attachment, 12 x Ø 12 mm	0003344000	25.- EUR
7 VG 3.34* Test tube attachment, 8 x Ø 16 mm	0003344100	25.- EUR
8 VG 3.35* Test tube attachment, 8 x Ø 20 mm	0003344200	25.- EUR
9 VG 3.36* Erlenmeyer flask attachment, 100 – 250 ml	0003342100	23.- EUR
10 VG 3.37* Microtiter plate attachment	0003344400	23.- EUR

MS 3 basic / digital accessories

	Ident. No.	Price
11 MS 3.1 Standard attachment	0003426300	14.- EUR
12 MS 3.3 Universal attachment	0003426600	14.- EUR
13 MS 1.21 One-hand insert	L001540	19.- EUR
14 MS 1.31 Test tube insert, 14 x Ø 10 mm	L001840	43.- EUR
15 MS 1.32 Test tube insert, 6 x Ø 12 mm	L001850	43.- EUR

16 MS 1.33 Test tube insert, 4 x Ø 16 mm	L001860	43.- EUR
17 MS 1.34 Test tube insert, without holes	L001830	20.- EUR
18 MS 3.5 PCR plate attachment, 96-well	0003428000	44.- EUR
19 MS 3.4 Microtiter plate attachment	0003426400	38.- EUR

Shakers | Accessories

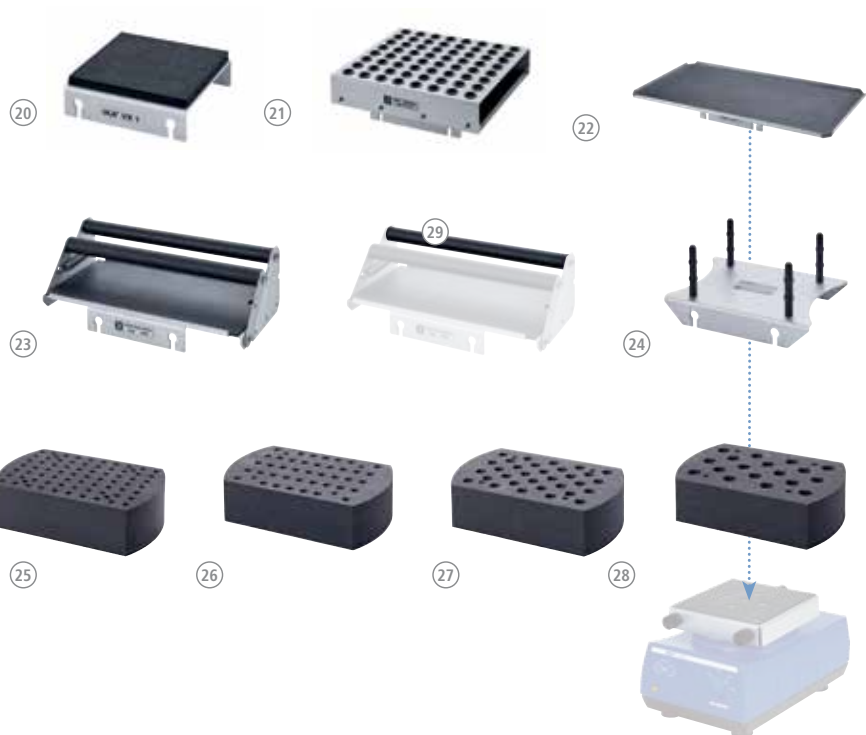

VXR basic accessories

	Ident. No.	Price
20 VX 1	0000607200	80.- EUR
One-hand attachment, 1 – 250 ml		
VX 2	0000568900	339.- EUR
Test tube attachment, 36 x Ø 16 mm		
21 VX 2E	0001618100	353.- EUR
Eppendorf attachment, 64 x 1.5 ml		
22 VX 7	0000953300	244.- EUR
Dish attachment, 410 x 210 mm		
23 VX 8	0000910400	563.- EUR
Universal attachment, 265 x 136 mm		

24 VX 11	0003627700	121.- EUR
Basic holder		
25 VX 11.1	0003659000	105.- EUR
Test tube insert, 70 x Ø 10 mm		
26 VX 11.2	0003659100	102.- EUR
Test tube insert, 41 x Ø 12 mm		
27 VX 11.3	0003659200	89.- EUR
Test tube insert, 32 x Ø 16 mm		
28 VX 11.4	0003659300	89.- EUR
Test tube insert, 18 x Ø 20 mm		
29 VX 8.1	0003375400	31.- EUR
Clamping roll		

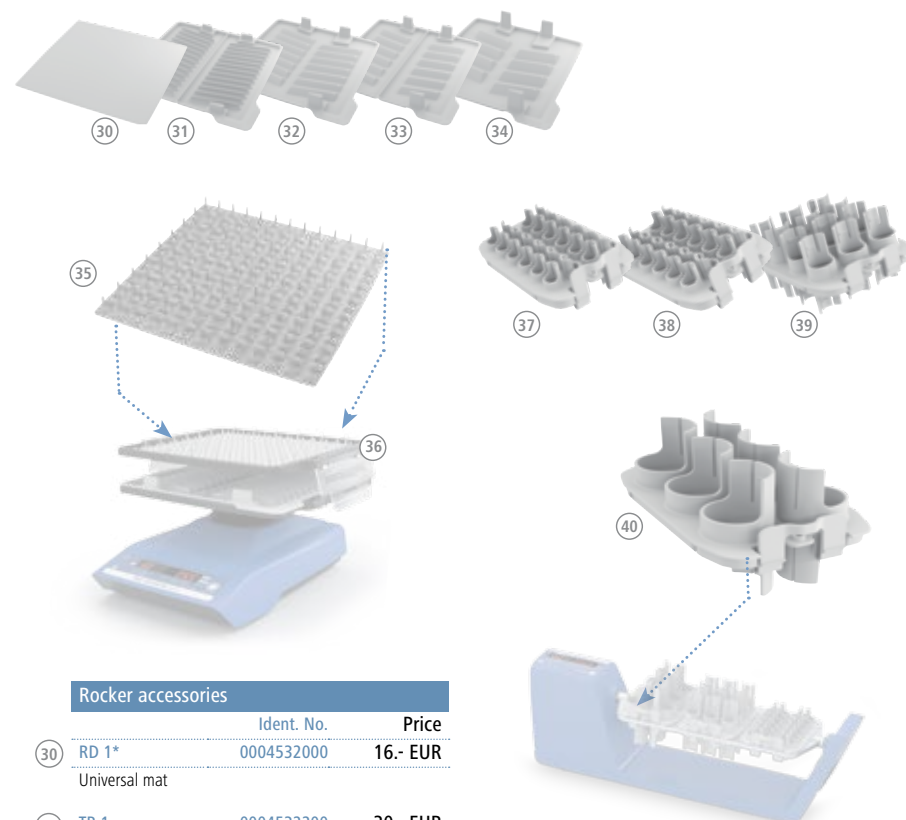

Rocker accessories

	Ident. No.	Price
30 RD 1*	0004532000	16.- EUR
Universal mat		
31 TB 1	0004532200	30.- EUR
Tray, 28 x 5 ml, Ø 12 mm		
32 TB 2	0004532300	30.- EUR
Tray, 16 x 15 ml, Ø 16 mm		
33 TB 3	0004532400	30.- EUR
Tray, 14 x 30 ml, Ø 25 mm		
34 TB 4	0004532500	30.- EUR
Tray, 10 x 50 ml, Ø 28 mm		
35 RD 2	0004532100	18.- EUR
Burled mat		
36 A 2	0004581700	54.- EUR
Second level attachment		

Trayster accessories

	Ident. No.	Price
37 TR 1	0004525100	33.- EUR
Tube insert, 24 x 1.5 ml, Ø 10 mm		
38 TR 2	0004525200	33.- EUR
Tube insert, 24 x 5 ml, Ø 12 mm		
39 TR 3	0004525300	33.- EUR
Tube insert, 12 x 15 ml, Ø 16 mm		
40 TR 4	0004525400	33.- EUR
Tube insert, 6 x 50 ml, Ø 28 mm		

* Included in the delivery

Shakers | Accessories

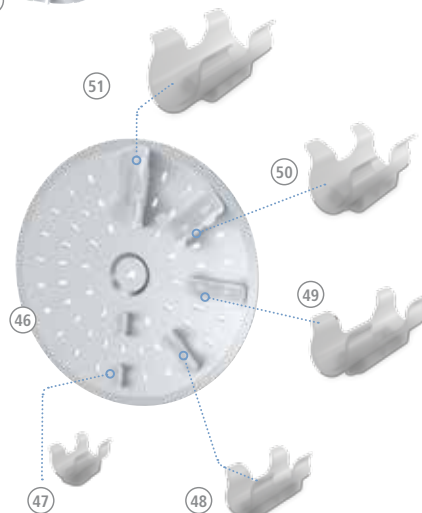
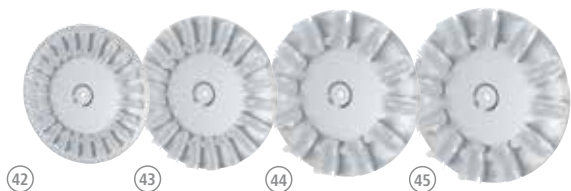

Loopster accessories

	Ident. No.	Price
41 DS 1	0004524000	163.- EUR
Tube attachment, 48 x 1.5 ml, Ø 10 mm		
42 DS 2	0004524100	117.- EUR
Tube attachment, 24 x 5 ml, Ø 12 mm		
43 DS 3	0004524200	117.- EUR
Tube attachment, 20 x 15 ml, Ø 16 mm		
44 DS 4	0004524300	117.- EUR
Tube attachment, 12 x 30 ml, Ø 25 mm		
45 DS 5	0004524400	117.- EUR
Tube attachment, 12 x 50 ml, Ø 28 mm		

46 DS 6	0004524500	99.- EUR
Universal disc		
47 DS 6.1	0004524600	28.- EUR
Spare clips, Ø 10 mm, 12 pcs.		
48 DS 6.2	0004524700	29.- EUR
Spare clips, Ø 12 mm, 12 pcs.		
49 DS 6.3	0004524800	31.- EUR
Spare clips, Ø 16 mm, 12 pcs.		
50 DS 6.4	0004524900	33.- EUR
Spare clips, Ø 25 mm, 12 pcs.		
51 DS 6.5	0004525000	33.- EUR
Spare clips, Ø 28 mm, 12 pcs.		

KS 130 basic / control accessories

	Ident. No.	Price
52 AS 130.1	0008017300	259.- EUR
Universal attachment, set-up plate 220 x 220 mm		
53 AS 130.2	0003115000	85.- EUR
Fixing clip attachment, set-up plate 230 x 230 mm		
54 AS 130.3	0003120000	80.- EUR
Dish attachment, set-up plate 220 x 340 mm		
55 AS 130.4	0003120300	190.- EUR
Test tube attachment, 64 x Ø 10 – 16 mm		

KS / HS 260 basic / control and KS 3000 accessories

	Ident. No.	Price
56 AS 260.1	0008017400	449.- EUR
Universal attachment, set-up plate 320 x 320 mm		
57 AS 260.2	0003115500	120.- EUR
Fixing clip attachment, set-up plate 330 x 330 mm		
AS 260.3	0003120600	101.- EUR
Dish attachment, set-up plate 320 x 320 mm		
58 AS 260.5	0003120900	490.- EUR
Separating funnel attachment		

Shakers | Accessories

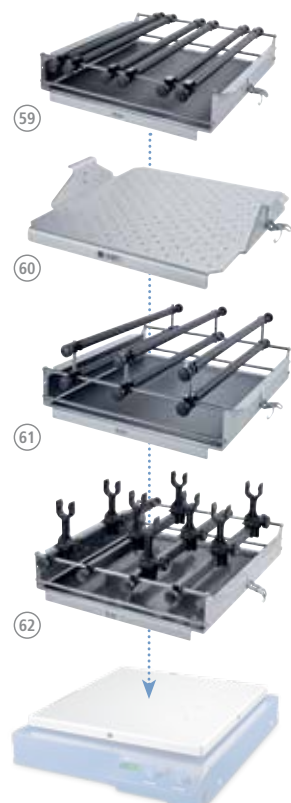

KS / HS 501 digital accessories

	Ident. No.	Price
59 AS 501.1	0008000200	1,433.- EUR
Universal attachment, set-up plate 420 x 420 mm		
60 AS 501.4	0002341100	941.- EUR
Fixing clip attachment, set-up plate 450 x 450 mm		
AS 501.5	0002339600	188.- EUR
Dish attachment, set-up plate 420 x 420 mm		
61 AS 501.2	0008000300	1,578.- EUR
Separating funnel attachment, 480 x 505 x 190 mm		
AS 501.3	0008000400	1,264.- EUR
Separating funnel attachment, 480 x 505 x 190 mm		
62 AS 501.6	0008000500	2,184.- EUR
Separating funnel attachment, 480 x 505 x 225 mm		



Other accessories

	Ident. No.	Price
63 AS 1.30	0003148000	238.- EUR
Basic holder for AS 130.1		
64 AS 1.60	0003149000	430.- EUR
Basic holder for AS 260.1		
65 AS 1.10	0002339700	636.- EUR
Basic holder for AS 501.1		
66 AS 1.31 AS 1.61 AS 1.11	0003030500	25.- EUR
	0003030501	32.- EUR
	0002339800	59.- EUR
Clamping roll for AS 130.1, AS 260.1, AS 501.1		



	Ident. No.	Price
AS 1.6	0001268400	41.- EUR
Clamping device for AS 501.1		
67 AS 1.7	0001269200	57.- EUR
Clamping device for AS 501.1		
AS 1.12	0002594500	118.- EUR
Supporting bar for AS 1.10		
68 AS 1.13	0002597000	114.- EUR
Ground section holder for AS 1.10		



	Ident. No.	Price
69 AS 2.1	0001234300	20.- EUR
Fixing clips, 25 ml		
70 AS 2.2	0001234400	20.- EUR
Fixing clips, 50 ml		
71 AS 2.3	0001234500	20.- EUR
Fixing clips, 100 ml		
72 AS 2.4	0001234600	39.- EUR
Fixing clips, 200 / 250 ml		
73 AS 2.5	0001234700	39.- EUR
Fixing clips, 500 ml		
74 AS 2.6	0003819300	39.- EUR
Fixing clips, 1000 ml		



STICKMAX
Universal adhesive mat,
200 x 200 mm

Ident. No. 0003920000
Price: 43.- EUR



KS 4000 accessories / ic control accessories

	Ident. No.	Price
75 AS 4000.1	0008022200	721.- EUR
Universal attachment, set-up plate 380 x 410 mm		
76 AS 4000.2	0003710100	627.- EUR
Fixing clip attachment, set-up plate 430 x 430 mm		
77 AS 4000.3	0003710000	165.- EUR
Dish attachment, set-up plate 430 x 430 mm		
78 AS 1.400	0003710200	430.- EUR
Basic holder for AS 4000.1		
79 AS 1.401	0003712000	41.- EUR
Clamping roll for AS 4000.1		
80 AS 1.402	0003712300	6.- EUR
Fastening screw for AS 4000.1		

Dispersers



IKA®'s ULTRA-TURRAX® – used for homogenizing, emulsifying or suspending. The digital display allows you to keep track of the speed and the development of the products focused on a soft start of the motor. There is a broad spectrum of dispersing tools to choose from. Common disperser applications include: homogenization of effluent samples, dispersing tasks under vacuum pressure, and PCR analysis.



High-performance dispersing instrument!

- > Work at high circumferential speeds
- > Enables the best possible results for any application



T 25
digital

Digital
Display

Digital display for precise monitoring of set and actual speeds



Wide selection of dispersing tools to suit your application



Motor protection against overload



Quick-connect coupling to exchange dispersing tools easily



reddot design award
winner 2012



German
Design Award

NOMINEE

ULTRA-TURRAX® Tube Drive

Patented



ULTRA-TURRAX®
Tube Drive

ULTRA-TURRAX®
Tube Drive control

Technical data

Motor rating input / output	20 / 17 W	20 / 17 W
Speed range / Turbo speed	300 – 6000 rpm / –	400 – 6000 rpm / 8000 rpm
Display / Speed display	LED (timer) / scale	OLED / digital
Timer	1 s – 29 min	10 s – 30 min (infinitely adjustable)
Reverse rotation interval	–	10 – 60 s
Dimensions (W x D x H)	100 x 160 x 40 mm	122 x 178 x 54 mm
Weight	0.75 kg	0.9 kg
Protection class DIN EN 60529	IP 20	IP 20
Interface	yes	yes
Voltage	100 – 240 V	100 – 240 V
Frequency	50/60 Hz	50/60 Hz

Price	517.- EUR	978.- EUR
	Ident. No. 0003646000	Ident. No. 0004135300



ULTRA-TURRAX® Tube
Drive Workstation

ULTRA-TURRAX® Tube Drive
control Workstation

Included with delivery

ULTRA-TURRAX® Tube Drive	1	1
SF-20 Tube with stirring device	2	1
DT-20 Tube with rotor-stator element	2	1
BMT-20 G / S Tube for grinding with glass (G) or stainless steel balls (S)	2	2
Removal hook for removal of rotor-stator	1	1
Power supply	1	1

Price	574.- EUR	1,035.- EUR
	Ident. No. 0003645000	Ident. No. 0003827500

No cleaning efforts
No cross-contamination
Reproducible test results



Tube
Drive
control



Turbo function for short time intensive mixing, homogenizing or grinding



Built-in program library for tests to be repeated under identical conditions



Reverse rotation switch to optimize mixing and crushing performance

OLED-
Display

Multilingual OLED display for simple and precise menu navigation



USB interface to control and document all the parameters using labworldsoft® software and for updating your firmware



Watch the video now:
www.ika.com/video



Accessories starting page 70 - 71

T-series ULTRA-TURRAX® Dispersers



T 10 standard PCR kit

reddot design award
winner 2012



NOMINEE



reddot design award
winner 2012



NOMINEE



Watch the video:
www.ika.com/video



Dispersing tools are not included in delivery

Technical data

	T 10 basic T 10 standard PCR kit	T 18 digital	T 25 digital
Motor rating input / output	125 / 75 W	500 / 300 W	700 / 500 W
Volume range (H ₂ O)	0.5 - 100 ml 1 - 100 ml	1 - 1500 ml	1 - 2000 ml
Viscosity max.	5000 mPas	5000 mPas	5000 mPas
Speed range	8000 - 30,000 rpm 8000 - 26,000 rpm	3000 - 25,000 rpm	3000 - 25,000 rpm
Speed display	scale	LED	LED
Speed control	stepless	stepless	stepless
Noise without element	65 dB(A)	75 dB(A)	75 dB(A)
Extension arm diameter	8 mm	13 mm	13 mm
Extension arm length	100 mm	160 mm	160 mm
Process type	batch	batch	batch
Dimensions (W x D x H)	56 x 66 x 178 mm 63 x 57 x 210 mm	87 x 106 x 271 mm	87 x 106 x 271 mm
Weight	0.5 kg 0.4 kg	2.5 kg	2.5 kg
Perm. ambient temperature	5 - 40 °C	5 - 40 °C	5 - 40 °C
Permissible relative moisture	80 %	80 %	80 %
Protect. class DIN EN 60529	IP 30	IP 20	IP 20
Interface	no	no	no
Voltage	230 V 220 - 240 V	200 - 240 V	200 - 240 V
Frequency	50/60 Hz	50/60 Hz	50/60 Hz

Price 1,188.- EUR | 1,135.- EUR 1,120.- EUR | 1,352.- EUR 1,649.- EUR

T 10 basic
Ident. No. 0003737000
T 10 PCR kit
Ident. No. 0004095500

T 18 digital
Ident. No. 0003720000
T 18 digital Package
Ident. No. 0009022800

Ident. No. 0003725000

Dispersing tools are not included in delivery

Technical data

	T 50 digital	T 65 basic	T 65 digital
Motor rating input / output	1100 / 700 W	1800 / 1500 W	2600 / 2200 W
Volume range (H ₂ O)	0.25 - 30 l	2 - 50 l	2 - 50 l
Viscosity max.	5000 mPas	5000 mPas	5000 mPas
Speed range	600 - 10,000 rpm	7200 rpm (fixed)	1000 - 9500 rpm
Speed display	LED	-	LED
Speed control	stepless	fixed	stepless
Noise without element	72 dB(A)	75 dB(A)	75 dB(A)
Extension arm diameter	16 mm	flange	flange
Extension arm length	220 mm	flange	flange
Process type	batch	batch	batch
Dimensions (W x D x H)	115 x 139 x 355 mm	185 x 400 x 450 mm	300 x 400 x 390 mm
Weight	5.76 kg	26 kg	30 kg
Perm. ambient temperature	5 - 40 °C	5 - 40 °C	5 - 40 °C
Permissible relative moisture	80 %	80 %	80 %
Protect. class DIN EN 60529	IP 20	IP 54	IP 54
Interface	no	no	no
Voltage	200 - 240 V	3 x 400 / 3 x 230 V	3 x 400 / 3 x 230 V
Frequency	50/60 Hz	50 Hz	50/60 Hz

Price 2,667.- EUR 3,976.- EUR | 7,159.- EUR 6,477.- EUR | 9,935.- EUR

Ident. No. 0003787000

Ident. No. 0004023500
T 65 basic Package
Ident. No. 0009023400

Ident. No. 0004234500
T 65 digital Package
Ident. No. 0009023500

Package details on page 171
Accessories starting page 72 - 83

ULTRA-TURRAX® Tube Drive | Accessories



ST Tube with stirring devices

	Ident. No.	Price
ST-20 (pack of 25)	0003703000	132.- EUR
ST-20-M-gamma (pack of 20)	0003700500	152.- EUR
ST-50 (pack of 10)	0003699500	59.- EUR
ST-50-M (pack of 10)	0003629500	65.- EUR
ST-50-M-gamma (pack of 10)	0003701500	99.- EUR



DT Tube with rotor-stator element

	Ident. No.	Price
DT-20 (pack of 25)*	0003703100	158.- EUR
DT-20-M-gamma (pack of 20)*	0003700600	174.- EUR
DT-20 eco (pack of 25)**	0020003207	138.- EUR
DT-50 (pack of 10)*	0003699600	71.- EUR
DT-50-M (pack of 10)*	0003629600	83.- EUR
DT-50-M-gamma (pack of 10)*	0003701600	109.- EUR
DT-50 eco (pack of 10)**	0020003213	69.- EUR

* Rotor-stator element made with PEEK

** Rotor-stator element made with PSU



BMT-S/G Tube for grinding with stainless steel (S) or glass (G) balls

	Ident. No.	Price
BMT-20-S (pack of 25)	0003703200	149.- EUR
BMT-20-G (pack of 25)	0003703300	149.- EUR
BMT-20-S-M-gamma (pack of 20)	0003700700	163.- EUR
BMT-50-S (pack of 10)	0003699700	76.- EUR
BMT-50-G (pack of 10)	0003699800	80.- EUR
BMT-50-S-M (pack of 10)	0003629700	99.- EUR
BMT-50-G-M (pack of 10)	0003629800	99.- EUR
BMT-50-S-M-gamma (pack of 10)	0003701700	93.- EUR



Cover for BMT tube

	Ident. No.	Price
TC-50; for 50 ml tubes (10 pcs.)	0003749800	28.- EUR
TC-20-M; with pierceable membrane for 20 ml tubes (25 pcs.)	0003749900	28.- EUR
TC-50-M; with pierceable membrane for 50 ml tubes (10 pcs.)	0003750000	28.- EUR

Balls for BMT tube

	Ident. No.	Price
Glass balls Ø 6 mm (250 g)	0003599200	43.- EUR
Stainless steel balls Ø 5 mm (250 g)	0003599300	43.- EUR



Dispersing tools | T 10 basic



	T 10 basic / standard stainless steel, standard		
Dispersing element	S 10 N – 5 G	S 10 N – 8 G	S 10 N – 10 G
Ident. No.	0003304000	0003305500	0003370100
Working range (H ₂ O)	0.5 – 10 ml	1 – 50 ml	1 – 100 ml
Stator / Rotor diameter	5 / 3.8 mm	8 / 6.1 mm	10 / 7.6 mm
Gap between rotor and stator	0.1 mm	0.25 mm	0.2 mm
Min. / max. immersion depth	20 / 75 mm	20 / 95 mm	20 / 100 mm
Shaft length	92 mm	115 mm	115 mm
Circumferential speed max.	6 m/s	9.6 m/s	11.9 m/s
Materials in contact with medium	PTFE, AISI 316L	PTFE, AISI 316L	PTFE, AISI 316L
FDA approved	yes	yes	yes
Price	1,048.- EUR	1,048.- EUR	1,048.- EUR



	T 10 basic / standard stainless steel, sawtooth	
Dispersing element	S 10 N – 8 G – ST	S 10 N – 10 G – ST
Ident. No.	0004446500	0004446700
Working range (H ₂ O)	1 – 50 ml	1 – 100 ml
Stator / Rotor diameter	8 / 6.1 mm	10 / 7.5 mm
Gap between rotor and stator	0.25 mm	0.25 mm
Min. / max. immersion depth	22 / 95 mm	23 / 100 mm
Shaft length	115 mm	115 mm
Circumferential speed max.	9.6 m/s	11.8 m/s
Materials in contact with medium	PTFE, AISI 316L	PTFE, AISI 316L
FDA approved	yes	yes
Price	1,048.- EUR	1,048.- EUR



	T 10 basic / standard plastic, disposable	
Dispersing element	S 10 D – 7 G – KS – 65	S 10 D – 7 G – KS – 110
Ident. No.	0020002076 (24 pcs.)	0020002075 (24 pcs.)
Working range (H ₂ O)	1 – 20 ml	1 – 40 ml
Stator / Rotor diameter	7 / 4.8 mm	7 / 4.8 mm
Gap between rotor and stator	0.3 mm	0.3 mm
Min. / max. immersion depth	20 / 45 mm	20 / 90 mm
Shaft length	65 mm	110 mm
Circumferential speed max.	7.5 m/s	7.5 m/s
Materials in contact with medium	Polycarbonate (PC) Polysulfon (PSU)	Polycarbonate (PC) Polysulfon (PSU)
FDA approved	yes	yes
Price	328.- EUR	374.- EUR

Dispersing tools | T 18 digital



	T 18 digital stainless steel, standard	
Dispersing element	S 18 N – 10 G	S 18 N – 19 G
Ident. No.	L004639	L004640
Working range (H ₂ O)	1 – 100 ml	10 – 1500 ml
Stator / Rotor diameter	10 / 7.5 mm	19 / 12.7 mm
Gap between rotor and stator	0.35 mm	0.4 mm
Min. / max. immersion depth	25 / 70 mm	35 / 170 mm
Shaft length	108 mm	204 mm
Circumferential speed max.	9.8 m/s	16.6 m/s
Materials in contact with medium	PTFE, AISI 316L	PTFE, AISI 316L
FDA approved	yes	yes
Price	819.- EUR	819.- EUR



	T 18 digital plastic, disposable	
Dispersing element	S 18 D – 10 G – KS	S 18 D – 14 G – KS
Ident. No.	0003452400 (12 pcs.)	0003452300 (12 pcs.)
Working range (H ₂ O)	10 – 100 ml	10 – 500 ml
Stator / Rotor diameter	10 / 6.75 mm	14 / 9.5 mm
Gap between rotor and stator	0.25 mm	0.35 mm
Min. / max. immersion depth	15 / 85 mm	15 / 85 mm
Shaft length	150 mm	150 mm
Circumferential speed max.	8.5 m/s	12 m/s
Materials in contact with medium	Polycarbonate (PC) Polyetheretherketon (PEEK)	Polycarbonate (PC) Polyetheretherketon (PEEK)
FDA approved	yes	yes
Price	197.- EUR	197.- EUR



Disposable tube S 18 / 25-ET50

For attaching onto plastic tools from S 18 D and S 25 D series.

Ident. No.	0003452500
Material	PP
Price	4.- EUR

Dispersing tools | T 25 digital



	T 25 digital stainless steel, standard	
Dispersing element	S 25 N – 8 G	S 25 N – 10 G
Ident. No.	0001024200	0000594000
Working range (H ₂ O)	1 – 50 ml	1 – 100 ml
Stator / Rotor diameter	8 / 6.1 mm	10 / 7.5 mm
Gap between rotor and stator	0.25 mm	0.35 mm
Min. / max. immersion depth	27 / 85 mm	22 / 85 mm
Shaft length	108 mm	105 mm
Circumferential speed max.	8.0 m/s	9.8 m/s
Materials in contact with medium	PTFE, AISI 316L	PTFE, AISI 316L
FDA approved	yes	yes
Price	1,136.- EUR	790.- EUR

	T 25 digital stainless steel, standard	
Dispersing element	S 25 N – 18 G	S 25 NK – 19 G
Ident. No.	0000593400	0002494700
Working range (H ₂ O)	10 – 1500 ml	25 – 1500 ml
Stator / Rotor diameter	18 / 12.7 mm	19 / 12.7 mm
Gap between rotor and stator	0.3 mm	0.3 mm
Min. / max. immersion depth	40 / 165 mm	40 / 165 mm
Shaft length	194 mm	194 mm
Circumferential speed max.	16.6 m/s	15.9 m/s
Materials in contact with medium	PTFE, AISI 316L	PTFE, AISI 316L
FDA approved	yes	no
Price	857.- EUR	777.- EUR

	T 25 digital stainless steel, standard	
Dispersing element	S 25 N – 25 G	S 25 N – 25 F
Ident. No.	0001713300	0001713800
Working range (H ₂ O)	50 – 2000 ml	100 – 2000 ml
Stator / Rotor diameter	25 / 17 mm	25 / 18 mm
Gap between rotor and stator	0.5 mm	0.5 mm
Min. / max. immersion depth	40 / 165 mm	40 / 165 mm
Shaft length	194 mm	194 mm
Circumferential speed max.	22.2 m/s	23.6 m/s
Materials in contact with medium	PTFE, AISI 316L	PTFE, AISI 316L
FDA approved	yes	yes
Price	1,097.- EUR	1,156.- EUR

IKA+

Saw Tooth (ST) dispersing tools

- > ST tools are recommended to use with tissue and other fibrous materials
- > Saw tooth designs create a cutting and tearing action for shredding fibrous materials
- > Made of high quality stainless steel



	T 25 digital stainless steel, sawtooth	
Dispersing element	S 25 N – 18 G – ST	S 25 N – 25 G – ST
Ident. No.	0004447300	0004447500
Working range (H ₂ O)	10 – 1500 ml	50 – 2000 ml
Stator / Rotor diameter	18 / 13.4 mm	25 / 20 mm
Gap between rotor and stator	0.25 mm	0.5 mm
Min. / max. immersion depth	40 / 165 mm	40 / 165 mm
Shaft length	194 mm	194 mm
Circumferential speed max.	17.5 m/s	26.2 m/s
Materials in contact with medium	PTFE, AISI 316L	PTFE, AISI 316L
FDA approved	yes	yes
Price	857.- EUR	1,097.- EUR

	T 25 digital stainless steel, sawtooth	
Dispersing element	S 25 – KD – 18 G – ST	S 25 – KD – 25 G – ST
Ident. No.	0020002973	0020002974
Working range (H ₂ O)	10 – 1500 ml	50 – 2000 ml
Stator / Rotor diameter	18 / 13.4 mm	20 / 25 mm
Gap between rotor and stator	0.25 mm	0.5 mm
Min. / max. immersion depth	40 – 185 mm	40 – 185 mm
Shaft length	194 mm	194 mm
Circumferential speed max.	–	–
Materials in contact with medium	PTFE, AISI 316L, ceramic	PTFE, AISI 316L, ceramic
FDA approved	yes	yes
Price	1,046.- EUR	1,310.- EUR

Dispersing tools | T 25 digital



Dispersing element

Ident. No.	0020002971
Working range (H ₂ O)	10 – 1500 ml
Stator / Rotor diameter	18 / 12.7 mm
Gap between rotor and stator	0.3 mm
Min. / max. immersion depth	40 – 185 mm
Shaft length	194 mm
Circumferential speed max.	–
Materials in contact with medium	PTFE, AISI 316L, ceramic
FDA approved	yes
Price	1,046.- EUR

T 25 digital stainless steel, ball bearing with PTFE seal

Dispersing element	S 25 – KD – 18 G	S 25 – KD – 25 G
Ident. No.	0020002971	0020002972
Working range (H ₂ O)	10 – 1500 ml	50 – 2000 ml
Stator / Rotor diameter	18 / 12.7 mm	25 / 17 mm
Gap between rotor and stator	0.3 mm	0.5 mm
Min. / max. immersion depth	40 – 185 mm	40 – 185 mm
Shaft length	194 mm	194 mm
Circumferential speed max.	–	–
Materials in contact with medium	PTFE, AISI 316L, ceramic	PTFE, AISI 316L, ceramic
FDA approved	yes	yes
Price	1,046.- EUR	1,310.- EUR

Dispersing element

Ident. No.	0020002975
Working range (H ₂ O)	100 – 2000 ml
Stator / Rotor diameter	25 / 18 mm
Gap between rotor and stator	0.5 mm
Min. / max. immersion depth	40 / 185 mm
Shaft length	194 mm
Circumferential speed max.	–
Materials in contact with medium	PTFE, AISI 316L, ceramic
FDA approved	yes
Price	1,321.- EUR

T 25 digital stainless steel, ball bearing with PTFE seal

Dispersing element	S 25 – KD – 25 F
Ident. No.	0020002975
Working range (H ₂ O)	100 – 2000 ml
Stator / Rotor diameter	25 / 18 mm
Gap between rotor and stator	0.5 mm
Min. / max. immersion depth	40 / 185 mm
Shaft length	194 mm
Circumferential speed max.	–
Materials in contact with medium	PTFE, AISI 316L, ceramic
FDA approved	yes
Price	1,321.- EUR



Dispersing element

Ident. No.	0002348000
Working range (H ₂ O)	10 – 1500 ml
Stator / Rotor diameter	18 / 12.7 mm
Gap between rotor and stator	0.3 mm
Min. / max. immersion depth	40 / 225 mm
Shaft length	270 mm
Circumferential speed max.	16.6 m/s
Materials in contact with medium	FFPM / SIC, AISI 316L
FDA approved	yes
Price	1,619.- EUR

T 25 digital stainless steel, slide ring seal

Dispersing element	S 25 KV – 18 G	S 25 KV – 25 G
Ident. No.	0002348000	0002466900
Working range (H ₂ O)	10 – 1500 ml	50 – 2500 ml
Stator / Rotor diameter	18 / 12.7 mm	25 / 17 mm
Gap between rotor and stator	0.3 mm	0.5 mm
Min. / max. immersion depth	40 / 225 mm	40 / 225 mm
Shaft length	270 mm	270 mm
Circumferential speed max.	16.6 m/s	22.2 m/s
Materials in contact with medium	FFPM / SIC, AISI 316L	FFPM / SIC, AISI 316L
FDA approved	yes	yes
Price	1,619.- EUR	1,661.- EUR

Dispersing element

Ident. No.	0002404000
Working range (H ₂ O)	100 – 2000 ml
Stator / Rotor diameter	25 / 18 mm
Gap between rotor and stator	0.5 mm
Min. / max. immersion depth	40 / 225 mm
Shaft length	270 mm
Circumferential speed max.	23.6 m/s
Materials in contact with medium	FFPM / SIC, AISI 316L
FDA approved	yes
Price	1,661.- EUR

T 25 digital stainless steel, slide ring seal

Dispersing element	S 25 KV – 25 F
Ident. No.	0002404000
Working range (H ₂ O)	100 – 2000 ml
Stator / Rotor diameter	25 / 18 mm
Gap between rotor and stator	0.5 mm
Min. / max. immersion depth	40 / 225 mm
Shaft length	270 mm
Circumferential speed max.	23.6 m/s
Materials in contact with medium	FFPM / SIC, AISI 316L
FDA approved	yes
Price	1,661.- EUR



Silentstream

The flow breaker is used to prevent vortexing and to minimize air induction into the medium

Ident. No. 0003754000 15.- EUR

Fits the following dispersing elements:

S 25 N – 18 G	S 25 KV – 25 G
S 25 N – 25 G	S 25 KV – 25 F
S 25 N – 25 F	S 18 N – 19 G
S 25 NK – 19 G	S 25 N – 18 G ST
S 25 KV – 18 G	S 25 N – 25 G ST



TS 25-3

Cleaning tool for cleaning three dispersing elements. The cleaning tool consists of an aluminum stand, three cleaning tubes (PP) and three covers with openings (PP).

Ident. No. 0020003013

Material tubes	PP	S 25 N – 18 G / 18 G – ST
Material lid	PP	S 25 N – 25 G / F / 25 G – ST
Material stand	aluminum anodized	S 25 KD – 18 G / 18 G – ST
		S 25 KD – 25 G / 25 F / 25 G – ST
		S 25 KV – 18 G / 25 G / 25 F

Price 75.- EUR

CT.15

Cleaning tube

Ident. No. 0020006595

Price 99.- EUR

NEW

Fits the following dispersing elements:

S 25 N – 18 G / 18 G – ST

S 25 N – 25 G / F / 25 G – ST

S 25 KD – 18 G / 18 G – ST

S 25 KD – 25 G / 25 F / 25 G – ST

S 25 KV – 18 G / 25 G / 25 F

Dispersing tools | T 50 digital



	T 50 digital stainless steel, standard	
Dispersing element	S 50 N – G 45 G	S 50 N – G 45 M
Ident. No.	0008003000	0008003300
Working range (H ₂ O)	0.5 – 20 l	0.5 – 15 l
Stator / Rotor diameter	45 / 36 mm	45 / 40.5 mm
Gap between rotor and stator	0.5 mm	0.25 mm
Min. / max. immersion depth	70 / 250 mm	70 / 250 mm
Shaft length	300 mm	290 mm
Circumferential speed max.	18.8 m/s	21.2 m/s
Materials in contact with medium	PTFE, AISI 316L	PTFE, AISI 316L
FDA approved	yes	yes
Price	2,254.- EUR	2,480.- EUR



	T 50 digital stainless steel, standard	
Dispersing element	S 50 N – G 45 F	
Ident. No.	0008003900	
Working range (H ₂ O)	0.25 – 10 l	
Stator / Rotor diameter	45 / 40 mm	
Gap between rotor and stator	0.5 mm	
Min. / max. immersion depth	70 / 250 mm	
Shaft length	290 mm	
Circumferential speed max.	20.9 m/s	
Materials in contact with medium	PTFE, AISI 316L	
FDA approved	yes	
Price	2,602.- EUR	



	T 50 digital stainless steel, slide ring seal	
Dispersing element	S 50 KG – HH – G 45 G	S 50 KG – HH – G 45 M
Ident. No.	0008003200	0008003500
Working range (H ₂ O)	0.5 – 20 l	0.5 – 15 l
Stator / Rotor diameter	45 / 36 mm	45 / 40.5 mm
Gap between rotor and stator	0.5 mm	0.25 mm
Min. / max. immersion depth	70 / 260 mm	70 / 250 mm
Shaft length	300 mm	300 mm
Circumferential speed max.	18.8 m/s	21.2 m/s
Materials in contact with medium	FFPM / SIC, AISI 316L	FFPM / SIC, AISI 316L
FDA approved	yes	yes
Price	3,414.- EUR	3,640.- EUR



	T 50 digital stainless steel, slide ring seal	
Dispersing element	S 50 KG – HH – G 45 F	S 50 KG – HH – G 45 G – ST
Ident. No.	0008004100	0010000648
Working range (H ₂ O)	0.25 – 10 l	0.5 – 20 l
Stator / Rotor diameter	45 / 40 mm	45 / 38 mm
Gap between rotor and stator	0.5 mm	0.5 mm
Min. / max. immersion depth	70 / 260 mm	70 / 260 mm
Shaft length	290 mm	290 mm
Circumferential speed max.	20.9 m/s	19.9 m/s
Materials in contact with medium	FFPM / SIC, AISI 316L	FFPM, SIC, AISI 316L
FDA approved	yes	yes
Price	3,762.- EUR	3,414.- EUR



	T 50 digital stainless steel, bronze bearing	
Dispersing element	S 50 B – G 45 G	S 50 B – G 45 M
Ident. No.	0010000633	0010000634
Working range (H ₂ O)	0.5 – 20 l	0.5 – 15 l
Stator / Rotor diameter	45 / 36 mm	45 / 40.5 mm
Gap between rotor and stator	0.5 mm	0.25 mm
Min. / max. immersion depth	70 – 250 mm	70 – 250 mm
Shaft length	300 mm	290 mm
Circumferential speed max.	–	–
Materials in contact with medium	AISI 316L, bronze	AISI 316L, bronze
FDA approved	no	no
Price	2,532.- EUR	2,758.- EUR



	T 50 digital stainless steel, bronze bearing	
Dispersing element	S 50 B – G 45 F	S 50 B – G 45 G – ST
Ident. No.	0010000635	0010000636
Working range (H ₂ O)	0.25 – 10 l	0.5 – 20 l
Stator / Rotor diameter	45 / 40 mm	45 / 38 mm
Gap between rotor and stator	0.5 mm	0.5 mm
Min. / max. immersion depth	70 / 250 mm	70 / 250 mm
Shaft length	290 mm	300 mm
Circumferential speed max.	–	–
Materials in contact with medium	AISI 316L, bronze	AISI 316L, bronze
FDA approved	no	no
Price	2,880.- EUR	2,532.- EUR

Dispersing tools | T 50 digital



T 50 digital stainless steel, special dispersing element	
Dispersing element	R 50 "high speed" stirring shaft
Ident. No.	0001689300*
Working range (H ₂ O)	0.25 – 30 l
Circumferential speed max.	15.7 – 23 m/s
Max. permissible rotor diameter	50 mm
Material	Stainless steel (AISI 316L)
Generator diameter	–
Min. / max. immersion depth	180 mm
Available seals	–
FDA approved	yes
Price	1,583.- EUR

* Included with delivery:
R 1402 Dissolver - Ident. No. 0001243300



T 50 digital stainless steel, special dispersing element		
Dispersing element	S 50 N – W 65 SK Cutting head	S 50 N – W 80 SMK Jet mixer head
Ident. No.	0008005100	0008006300
Working range (H ₂ O)	1 – 10 l	1 – 50 l
Circumferential speed max.	–	–
Max. permissible rotor diameter	–	–
Material	–	–
Generator diameter	65 mm	80 mm
Min. / max. immersion depth	80 / 350 mm	140 / 350 mm
Available seals	S 50 N	S 50 N
FDA approved	yes	yes
Price	2,529.- EUR	2,365.- EUR



T 50 digital stainless steel, standard		
Dispersing element	S 50 KD - G 45 G	S 50 KD - G 45 G - ST
Ident. No.	0010000629	0010000632
Working range (H ₂ O)	0.5 – 20 l	0.5 – 20 l
Stator / Rotor diameter	45 / 36 mm	45 / 38 mm
Gap between rotor and stator	0.5 mm	0.5 mm
Min. / max. immersion depth	70 / 260 mm	70 / 260 mm
Shaft length	300 mm	300 mm
Circumferential speed max.	18.8 m/s	19.9 m/s
Materials in contact with medium	AISI 316L, PTFE, ceramic	AISI 316L, PTFE, ceramic
FDA approved	yes	yes
Price	3,028.- EUR	3,028.- EUR

T 50 digital stainless steel, slide ring seal		
Dispersing element	S 50 KD - G 45 M	S 50 KD - G 45 F
Ident. No.	0010000630	0010000631
Working range (H ₂ O)	0.5 – 15 l	0.25 – 10 l
Stator / Rotor diameter	45 / 40.5 mm	45 / 40 mm
Gap between rotor and stator	0.25 mm	0.5 mm
Min. / max. immersion depth	70 / 260 mm	70 / 260 mm
Shaft length	300 mm	300 mm
Circumferential speed max.	21.2 m/s	20.9 m/s
Materials in contact with medium	AISI 316L, PTFE, ceramic	AISI 316L, PTFE, ceramic
FDA approved	yes	yes
Price	3,254.- EUR	3,376.- EUR

Dispersing tools | T 65 basic & digital

NEW

	T 65 basic digital stainless steel, ceramic bearing		
Dispersing element	S 65 C - G 65 G	S 65 C - G 65 M	S 65 C - G 65 F
Ident. No.	0010001665	0010001666	0010001667
Working range (H ₂ O)	2 – 50 l	2 – 40 l	2 – 30 l
Stator / Rotor diameter	65 / 53 mm	65 / 53 mm	65 / 53 mm
Gap between rotor and stator	0.5 mm	0.5 mm	0.5 mm
Min. / max. immersion depth	90 – 450 mm	90 – 450 mm	90 – 450 mm
Shaft length	520 mm	520 mm	520 mm
Circumferential speed max.	26.4 m/s	28.8 m/s	28.8 m/s
Materials in contact with medium	FKM, ceramic, AISI 316L	FKM, ceramic, AISI 316L	FKM, ceramic, AISI 316L
FDA approved	yes	yes	yes
Price	2,985.- EUR	3,216.- EUR	3,357.- EUR

	T 65 basic digital stainless steel, ball bearing with PTFE seal		
Dispersing element	S 65 KD – G 65 G	S 65 KD – G 65 M	S 65 KD – G 65 F
Ident. No.	0010000641	0010000642	0010000643
Working range (H ₂ O)	2 – 50 l	2 – 40 l	2 – 30 l
Stator / Rotor diameter	65 / 53 mm	65 / 58 mm	65 / 58 mm
Gap between rotor and stator	0.5 mm	0.5 mm	0.5 mm
Min. / max. immersion depth	90 – 450 mm	80 – 450 mm	80 – 450 mm
Shaft length	520 mm	520 mm	520 mm
Circumferential speed max.	26.4 m/s	28.8 m/s	28.8 m/s
Materials in contact with medium	FKM, PTFE, AISI 316L	FKM, PTFE, AISI 316L	FKM, PTFE, AISI 316L
FDA approved	yes	yes	yes
Price	3,072.- EUR	3,303.- EUR	3,444.- EUR

	T 65 basic digital stainless steel, slide ring seal	
Dispersing element	S 65 KG – HH – G 65 G	S 65 KG – HH – G 65 M
Ident. No.	0008005500	0008005700
Working range (H ₂ O)	2 – 50 l	2 – 40 l
Stator / Rotor diameter	65 / 58 mm	65 / 58 mm
Gap between rotor and stator	0.5 mm	0.5 mm
Min. / max. immersion depth	90 / 450 mm	80 / 450 mm
Shaft length	520 mm	510 mm
Circumferential speed max.	21.9 m/s	21.9 m/s
Materials in contact with medium	FFPM / SIC, AISI 316L	FFPM / SIC, AISI 316L
FDA approved	yes	yes
Price	3,419.- EUR	3,650.- EUR

	T 65 basic digital stainless steel, slide ring seal
Dispersing element	S 65 KG – HH – G 65 F
Ident. No.	0008005900
Working range (H ₂ O)	2 – 30 l
Stator / Rotor diameter	65 / 58 mm
Gap between rotor and stator	0.5 mm
Min. / max. immersion depth	80 / 450 mm
Shaft length	500 mm
Circumferential speed max.	21.9 m/s
Materials in contact with medium	FFPM / SIC, AISI 316L
FDA approved	yes
Price	3,791.- EUR

NEW

	T 65 basic digital dissolver disc for dispersing elements	
Dispersing element	D 60	D 80
Ident. No.	0020008388	0020008389
Working range (H ₂ O)	2 – 30 l	2 – 50 l
Stator / Rotor diameter	– / 60 mm	– / 80 mm
Gap between rotor and stator	–	–
Min. / max. immersion depth	90 – 450 mm	90 – 450 mm
Shaft length	520 mm	520 mm
Circumferential speed max.	29.8 m/s	39.8 m/s
Materials in contact with medium	FKM, PTFE, AISI 316L	FKM, PTFE, AISI 316L
FDA approved	yes	yes
Price	362.- EUR	414.- EUR

For dispersing instrument	Dispersing element shaft / Agitator shaft	With seal or bearing type*	Generator or element**	With outer diameter (mm)	Degree of fineness achieved***
T 10 basic	S 10	N	–	5 / 8 / 10	G
T 18 digital	S 18	N	–	10 / 19	G
T 25 digital	S 25	N / KV / NK / KD	–	8 / 10 / 18 / 19 / 25	G / F
T 50 digital	S / R 50	N / B / KD	G / W	45 / 65 / 80	G / M / F
T 65 basic	S 65	KG – HH / KD	G	65	G / M / F
T 65 digital	S 65	KG – HH / KD	G	65	G / M / F

- * N = PTFE bearing
- KV = Ball bearing with vacuum-tight sliding-ring seal with silicon carbide seal rings
- NK = PTFE bearing with additional ball bearing without seal
- KG – HH = Ball bearing with sliding-ring seals of hard metal allow with FFPM seals rings
- B = Bronze bearing
- KD = Ball bearing with PTFE seal
- C = Ceramic bearing
- ** G = Proved configuration
- W = Special element
- *** G = Coarse
- M = Medium
- F = Fine

magic LAB®



magic LAB®

 Stainless Steel

Materials in contact with medium made of stainless steel



7 interchangeable modules available



Handy transport box with integrated power supply included in delivery

magic LAB® with module UTL

magic LAB®

Technical data

Motor power	900 W
Speed range (40 m/s)	3000 – 26,000 rpm
Operating voltage	220 – 240 V
Frequency	50 – 60 Hz
Process pressure	up to 2.5 bar
Product temperature in continuous operation	up to 80 °C
In short time operation (up to 18 min/h)	up to 120 °C
Materials in contact with the medium	Stainless steel (AISI 316L and AISI 316Ti)
Sealing material	PTFE-compound
Shaft sealing ring	Standard FPM
Elastomers in the working chamber	optional EPDM (FDA), FFPM
Dimensions (W x D x H)	170 x 270 x 215 mm

Price

7,390.- EUR

Ident. No. U078310

magic LAB®

- > Suitable for a wide range of applications
- > Ideal for inline, circulating and classical batch processing
- > Safe scale-up due to many constant work parameters
- > Modular construction
- > Simple heating and cooling of all modules
- > Easy and quick exchange of the modules
- > With rotor-stator systems operating at circumferential speeds up to 40 m/s



Multifunction storage and transportation box

One machine for many mixing tasks

The magic LAB® is a unique and multi-functional small-scale laboratory machine. It is designed for mixing, dispersing, wet milling and incorporation of powders into liquids.

The magic LAB® is most frequently used for the development of new products or for optimizing of existing process techniques, particularly in the chemical, cosmetic, pharmaceutical and food industries. It is an ideal machine for continuous, circulating and batch processing with interchangeable modules.



magic LAB®



magic LAB® with module UTC
Dispersing/mixing in batch operation



CMX Periphery
The integrated solution for wetting
of most difficult powders



1 l module Micro-Plant
with exchangeable modules
(UTL / DR / MK / MKO)



2 l module Micro-Plant
with exchangeable modules
(UTL / DR / MK / MKO)



Three-stage dispersing for manufacturing of fine emulsions and suspensions.



Wet milling by means of spiral gearing milling tool. Production of colloidal solutions. Adjustable flow rate and friction by setting the gap between the rotor and stator.



Suction of solids into fluids in the recirculation process. Free from lumps and dust processing of powders and granules. Energy-efficient homogeneous mixing.



Wet milling as with the MK-module. The cones are furnished with an abrasion-resistant tungsten carbide-cobalt coating. Narrowest grinding gap enables producing of even finer suspensions.



Continuous mixing and dispersion of powders in liquids. Patented process. Fast and homogeneous mixing in only one passage, avoiding agglomerates. Solids content up to 80%.



Finest wet milling of granular, viscous and pasty products by means of two corundum disks. High shear forces mill the product finely between the rotor and the axially movable stator.

	Module DISPAX-REACTOR® DR	Module colloid mill MK	Module CMX
Technical data			
Flow rate	80 l/h (H ₂ O)	200 l/h (H ₂ O)**	1000 l/h (H ₂ O)**
Standard rotational speed	14,600 rpm	14,600 rpm	11,000 rpm
Circumferential speed	23 m/s	23 m/s*	19.5 m/s*
Price	1,190.- EUR	2,700.- EUR	2,400.- EUR
	Ident. No. U078352	Ident. No. U076662	Ident. No. U075333

* At standard rotational speed and 50 Hz

** at minimal gap between the rotor and stator

	Module cone mill MKO	Module MHD (mixing, homogenising, dispersing)	Module corundum disk mill MCD
	25 l/h (H ₂ O)**	60 l/h (H ₂ O)**	1 – 20 kg/h**
	14,600 rpm	14,600 rpm	12,000 rpm
	23 m/s*	23 m/s*	19.5 m/s*
Price	2,700.- EUR	2,110.- EUR	2,700.- EUR
	Ident. No. U079664	Ident. No. U075262	Ident. No. 20001675

Mills



IKA® laboratory mills are ideal for grinding, pulverizing or chopping samples for routine analyses, either in batch or continuous operation. Grinding results are achieved up to 1 µm particle size or 0.25 mm defined ultimate fineness. Due to a broad spectrum of easily interchangeable beaters and cutters, IKA® mills are highly effective for a variety of applications and can also be scaled up for larger volumes.



Redesigned batch mill

- > The mill can only be operated with a closed lid
- > The lid can only be opened at a standstill
- > A quick stop feature further increases the safety of the user

A 10 basic

LED Display

Digital timer



Quiet operation



Interval operation and easy operation by foil keypad

Error code Display

Error code display



Integrated cooling connections



Grinding chamber reduction for small sample sizes



Mills

- > Tube Mill 100 control
- > Works with 40 ml and 100 ml chamber
- > Stronger motor
- > New coupling for easy cleaning



Watch the video:
www.ika.com/video



reddot design award
winner 2013

Patented



NEW

	Tube Mill control	Tube Mill 100 control
Technical data		
Motor rating input / output	100 / 80 W	100 / 80 W
Speed range	5000 – 25,000 rpm	5000 – 25,000 rpm
Useful volume	40 ml	100 ml
Duty cycle (ON / OFF)	5 s – 3 min (timer)	5 s – 3 min (timer)
Circumferential speed	65 m/s	65 m/s
Max. feed hardness	5 Mohs	5 Mohs
Max. feed grain size	10 mm	10 mm
Grinding chamber material	Transparent plastic (PP)	Transparent plastic (PP)
Dimensions (W x D x H)	180 x 300 x 170 mm	180 x 300 x 212 mm
Weight	2.7 kg	2.8 kg
Permissible relative moisture	80%	80%
Protection class acc. to DIN EN 60529	IP 30	IP 30
Price	1,683.- EUR	1,869.- EUR
	Ident. No. 0004180000*	Ident. No. 0020007144**

* 2 x MT 40 and 1 x MMT 40 included in the delivery.

** 1 x MT 40, 1 x MT 100 and 1 x MMT 40 included in the delivery.



Cross-contamination free
No cleaning required
Precise milling results
Large application range

Disposable grinding chamber, 40 ml

Ident. No. Price



MT 40.10 0004425000 60.- EUR

Disposable grinding chamber 40 ml, 10 pieces

MT 40.100 0020001173 538.- EUR

Disposable grinding chamber 40 ml, 100 pieces



MTC 40.100 0020001182 46.- EUR

Cover for MT 40

MT 40.10 steril 0020001984 105.- EUR

Disposable grinding chamber steril 40 ml, 10 pieces

Multiple grinding chamber, 40 ml

Ident. No. Price



MMT 40.1 0020003165 195.- EUR

MMT 40.1 stainless steel package, includes 1 MMT 40 chamber, 25 sealings, 5 beaters, 5 couplings



A-MMT 40.100 0020003378 128.- EUR

A-MMT 40.100 abrasion set spare parts, includes 100 sealings, 10 beaters, 10 couplings

Disposable grinding chamber, 100 ml

Ident. No. Price



MT 100.10 0020008386 81.- EUR

Disposable grinding chamber, 100 ml

MT 100.50 0020006984 373.- EUR

Disposable grinding chamber, 100 ml, 10 pieces

Mills

M 20



Removable

Removable, easy-to-clean,
high-grade steel chamber

Double-walled

Double-walled grinding
chamber

Technical data	A 10 basic	A 11 basic	M 20 Universal mill
Motor rating input/output	300 / 240 W	160 / 100 W	450 / 225 W
Speed range	25,000 rpm (fixed)	28,000 rpm (fixed)	20,000 rpm (fixed)
Useful volume	50 ml	80 ml (optional 250 ml)	250 ml
Duty cycle (ON / OFF)	5 / 10 min	1 / 10 min	7 / 10 min
Overload protection	yes	yes	yes
Circumferential speed	73 m/s	53 m/s	72 m/s
Max. feed hardness	5 Mohs*	6 Mohs*	5 Mohs*
Max. feed grain size	6 mm	10 mm	7 mm
Grinding chamber material	stainless steel 1.4301	stainless steel 1.4571	stainless steel 1.4301
Dimensions (W x D x H)	130 x 145 x 250 mm	85 x 85 x 240 mm	170 x 170 x 350 mm
Weight	2.9 kg	1.5 kg	6.6 kg
Permissible ambient temperature	5 – 40 °C	5 – 40 °C	5 – 40 °C
Permissible relative moisture	80%	80%	80%
Protection class acc. to DIN EN 60529	IP 41	IP 43	IP 21
Price	1,612.- EUR	1,875.- EUR	5,089.- EUR
	Ident. No. 0004020700**	Ident. No. 0002900000	Ident. No. 0001603600

* 9 Mohs with accessory beater / cutter M 22, A 10.3 or A 11.3

** A 10.1 and A 10.4 included in the delivery of A 10 basic

A 11
basic

Quiet operation

Easily exchangeable
beater / cutter

Universal mill | Microfine grinder



Technical data	MF 10 basic
Motor rating input/output	1000 / 500 W
Speed range	3000 – 6500 rpm
Speed display	no
Useful volume	max. 5 kg/h
Duty cycle (ON / OFF)	120 / 30 min
Overload protection	yes
Circumferential speed	22.5 m/s
Max. feed hardness	6 Mohs
Max. feed grain size	15 mm
Materials in contact with medium	stainless steel (AISI 304)
Dimensions (W x D x H)	320 x 300 x 380 mm
Weight	11.9 kg (incl. MF 10.1)
Permissible ambient temperature	5 – 40 °C
Permissible relative moisture	80%
Protection class acc. to DIN EN 60529	IP 22
Price	3,787.- EUR
	Ident. No. 0002836000

Technical data	MF 10.1 Cutting-grinding head MF 10.2 Impact-grinding head
Circumferential speed	24.5 m/s 34 m/s
Max. granularity of task	max. 15 mm max. 10 mm
Dimensions including MF 10 basic	320 x 300 x 560 mm 320 x 300 x 450 mm
Weight including MF 10 basic	11.9 kg 12.4 kg
Grinding chamber material	stainless steel 1.4308

Price
MF 10.1: 2,831.- EUR
MF 10.2: 2,599.- EUR

- 1 MF 10.1
Cutting-grinding head
Ident. No. 0002870900
- 2 MF 10.2
Impact-grinding head
Ident. No. 0002871000

MF 10
basic



Easily interchangeable heads



Easy to clean working surface made of stainless steel



Powerful drive

Powerful



Mills | Accessories

A 10 basic accessories

	Ident. No.	Price
--	------------	-------



A 10.1	0025001680	36.- EUR
--------	------------	----------

Stainless steel cutter



A 10.2	0025001162	115.- EUR
--------	------------	-----------

Star-shaped cutter



A 10.3	0025001161	211.- EUR
--------	------------	-----------

Hard metal cutter



A 10.4	0025001664	83.- EUR
--------	------------	----------

Grinding chamber reduction

A 11 basic accessories

	Ident. No.	Price
--	------------	-------



A 11.1	0002904600	81.- EUR
--------	------------	----------

Spare beater, stainless steel



A 11.2	0002905200	138.- EUR
--------	------------	-----------

Cutting blade, stainless steel



A 11.3	0002983000	175.- EUR
--------	------------	-----------

Beater, stainless steel, coated with chromium carbide



A 11.4	0002904100	478.- EUR
--------	------------	-----------

Grinding chamber, polycarbonate, 250 ml



A 11.5	0002983100	350.- EUR
--------	------------	-----------

Spare grinding chamber, Tefcel, 80 ml



A 11.6	0003302900	378.- EUR
--------	------------	-----------

Double beater, titanium



A 11.7	0003048700	192.- EUR
--------	------------	-----------

Funnel, jacket PTFE, sieve stainless steel



M 20 accessories

	Ident. No.	Price
--	------------	-------



M 21	0000328200	66.- EUR
------	------------	----------

Spare cutter, stainless steel



M 22	0000521800	281.- EUR
------	------------	-----------

Hard metal cutter, tungsten carbide



M 23	0001443400	131.- EUR
------	------------	-----------

Star-shaped cutter, stainless steel



M 20.1	0008006200	2,880.- EUR
--------	------------	-------------

Grinding chamber, 250 ml

MF 10 basic accessories

	Ident. No.	Price
--	------------	-------

MF 0.25	0002938900	299.- EUR
---------	------------	-----------

Sieve, Ø 0.25 mm

MF 0.5	0002939000	217.- EUR
--------	------------	-----------

Sieve, Ø 0.5 mm

MF 1.0	0002939200	217.- EUR
--------	------------	-----------

Sieve, Ø 1 mm

MF 2.0	0002939400	217.- EUR
--------	------------	-----------

Sieve, Ø 2 mm

MF 3.0	0002939500	236.- EUR
--------	------------	-----------

Sieve, Ø 3 mm

MF 4.0	0002939600	277.- EUR
--------	------------	-----------

Sieve, Ø 4 mm

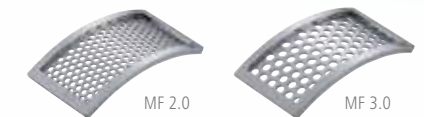
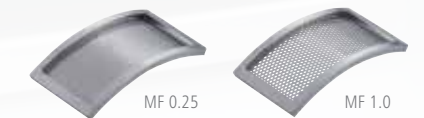

Universal mill | Pilotina

IKA®+

The IKA® Pilotina can be used for a great variety of milling functions in a diverse range of industrial tasks.



The universal 2 in 1 mill for dry products



The cutting mill system
The preeminent choice for the disintegration of smooth, sticky, elastic or fibrous materials.



The impact milling system
The foremost option for the disintegration of hard and brittle materials.

	Pilotina MU	Pilotina MC	Pilotina MI
Technical data			
Motor power	3 kW	1.5 kW	1.5 kW
Speed range	1500 – 4500 rpm	1500 rpm	3000 rpm
Speed indication	digital	no	no
Capacity (depending on the final fineness)	approx. 60 – 80 kg/h	approx. 60 kg/h	approx. 80 kg/h
Overload protection	yes	yes	yes
Circumferential speed	9 – 34 m/s	9 m/s	22 m/s
Max. charging hardness	3 or 6 Mohs	3 Mohs	6 Mohs
Approx. max. charging size	65 x 60 or 25 mm	65 x 60 mm	25 mm
Dimensions, approx. (L x W x H)	485 x 575 x 700 mm	485 x 575 x 700 mm	485 x 575 x 630 mm
Weight, approx.	80 kg	70 kg	70 kg
Protection type	IP 55	IP 55	IP 55
Price	21,400.- EUR	14,900.- EUR	16,200.- EUR
	Ident. No. U105421	Ident. No. U106466	Ident. No. U106465

Pilotina

Easily interchangeable funnels



Easy conversion from a cutting mill to an impact mill



Circumferential speed adjustable to requirements of the milling process



Safe design of inlet and outlet

Universal 2 in 1 mill for dry products

The IKA® Pilotina is a dry milling system in pilot plant scale, available in 3 different configurations. The modular design allows an easy modification from impact to cutting mill and vice versa within shortest time. Your advantage: one machine, two milling principles, all this without making any compromise regarding disintegration quality. Due to the powerful, frequency controlled 3 kW drive with digital indication the circumferential speed of the tool can be adjusted to the required milling process in an optimum way.

Dry Block Heaters



IKA® has a diverse range of dry block heaters designed to accommodate various interchangeable heating blocks. They provide precise temperature control for reproducible results. These digital block heaters are ideal for melting and boiling point determination, enzyme reactions, incubation and activation of cultures, immunoassays, DNA denaturation, culture media tests, coagulation tests, blood urea- nitrogen determinations and in situ hybridizations.



Precise temperature control!

- > Bushing acc. to DIN 12878
- > Rapid heat up rates
- > Exceptional temperature uniformity
- > PT 1000.60 temperature sensor included in the delivery

Dry Block Heater 3



Temperature display for the actual / set-point temperatures, up / down arrows for set-point control



A wide range of interchangeable heating blocks to fit any sample tube or plate



External probe for accurate temperature control



Timer display for accurate and reproducible conditions, up / down arrows for set-point control



Dry Block Heaters

IKA® dry block heaters are highly versatile suitable for broad range of applications.

- > DNA extractions
- > DNA analysis
- > Melting point determination
- > Boiling point determination
- > Immunoassays
- > Enzyme reactions
- > Enzymatic processes
- > Enzyme activity studies
- > In situ hybridization
- > Blood-urea-nitrogen determinations
- > Nucleic acid hybridization
- > Coagulation studies
- > Biochemical processes
- > Incubation and activation of cultures
- > Blood examinations
- > Fertile ground processing
- > Restriction digest
- > Denaturation



	Dry Block Heater 1	Dry Block Heater 2
Technical data		
Number of blocks	1	2
Heat output	165 W	250 W
Heating temperature range	RT +5 °C – 120 °C	RT +5 °C – 120 °C
Display	LED	LED
Heat control accuracy	± 1 K	± 1 K
Connection for external temperature sensor	DIN 12878	DIN 12878
Control accuracy with sensor	± 1 K	± 1 K
Material of the blocks	aluminum alloy	aluminum alloy
Timer	1 min to 99h 59min	1 min to 99h 59min
Dimensions (W x D x H)	151 x 228 x 73 mm	151 x 304 x 73 mm
Price	876.- EUR	1,018.- EUR
	Ident. No. 0004025100*	Ident. No. 0004025200*

IKA®+

PT 1000.60 temperature sensor included in the delivery.



	Dry Block Heater 3	Dry Block Heater 4
	3	4
Heat output	330 W	412 W
Heating temperature range	RT +5 °C – 120 °C	RT +5 °C – 120 °C
Display	LED	LED
Heat control accuracy	± 1 K	± 1 K
Connection for external temperature sensor	DIN 12878	DIN 12878
Control accuracy with sensor	± 1 K	± 1 K
Material of the blocks	aluminum alloy	aluminum alloy
Timer	1 min to 99h 59min	1 min to 99h 59min
Dimensions (W x D x H)	151 x 380 x 73 mm	151 x 456 x 73 mm
Price	1,150.- EUR	1,458.- EUR
	Ident. No. 0004025300*	Ident. No. 0004025400*

* PT 1000.60 temperature sensor included in the delivery of all the dry block heaters

Dry Block Heaters | Accessories

Single blocks (95 x 76 x 51)	Material	Holes Ø	No. of holes	Hole depth (mm)	Ident. No.	Price
Micro centrifuge tubes						
DB 1.1 single block, PCR tubes, 0.5 ml	aluminum anodized	Ø 7.9 mm	30	27.6	0004467600	89.- EUR
DB 1.2 single block, Eppendorf tubes, 1.5 ml	aluminum anodized	Ø 11.5 mm	20	36.9	0004467700	74.- EUR
DB 1.3 single block, Microtubes, 1.5 ml	aluminum anodized	Ø 11.1 mm	20	39.1	0004467800	74.- EUR
DB 1.4 single block, Eppendorf tubes, 2.0 ml	aluminum anodized	Ø 11.5 mm	20	38.1	0004467900	74.- EUR
DB 1.5 single block, Corning tubes, 2.0 ml	aluminum anodized	Ø 10.9 mm	20	38.1	0004468000	74.- EUR
Conical bottom centrifuge tubes						
DB 2.1 single block, Conical tubes, 15 ml	aluminum anodized	Ø 17.1 mm	12	44.5	0004468100	89.- EUR
DB 2.2 single block, Conical tubes, 50 ml	aluminum anodized	Ø 29.0 mm	5	47.6	0004468200	88.- EUR
Combination blocks						
DB 3.1 single block, test tube combination, 6 / 12 / 13 / 25 mm	aluminum anodized	Ø 8.3 / Ø 13.9 / Ø 26.2 mm	6 / 5 / 3	48.4 / 48.4 / 48.4	0004468300	88.- EUR
DB 3.2 single block, centrifuge combination, 1.5 / 15 / 50 ml	aluminum anodized	Ø 11.1 / Ø 17.1 / Ø 29.0 mm	4 / 3 / 2	39.1 / 44.5 / 47.6	0004468400	88.- EUR
DB 3.3 single block, microtube combination, 0.5 / 1.5 / 2 ml	aluminum anodized	Ø 7.9 / Ø 11.1 / Ø 11.5 mm	6 / 10 / 5	27.6 / 39.1 / 38.1	0004468500	89.- EUR
Standard test tubes						
DB 4.1 single block, Round tubes, 6 mm	aluminum anodized	Ø 8.3 mm	30	48.4	0004468600	98.- EUR
DB 4.2 single block, Round tubes, 10 mm	aluminum anodized	Ø 10.7 mm	24	48.4	0004468700	92.- EUR
DB 4.3 single block, Round tubes, 12 / 13 mm	aluminum anodized	Ø 13.9 mm	16	48.4	0004468800	89.- EUR
DB 4.4 single block, Round tubes, 12 / 13 mm	aluminum anodized	Ø 13.9 mm	20	48.4	0004468900	92.- EUR
DB 4.5 single block, Round tubes, 15 / 16 mm	aluminum anodized	Ø 17.5 mm	12	48.4	0004469000	89.- EUR
DB 4.6 single block, Round tubes, 20 mm	aluminum anodized	Ø 21 mm	8	48.4	0004469100	88.- EUR
DB 4.7 single block, Round tubes, 25 mm	aluminum anodized	Ø 26.2 mm	6	48.4	0004469200	88.- EUR
DB 4.8 single block, Round tubes, 35 mm	aluminum anodized	Ø 35 mm	4	47.6	0004469300	86.- EUR
DB 4.9 single block, Round tubes, 17 / 18 mm	aluminum anodized	Ø 19.1 mm	12	48.4	0004469400	89.- EUR
Vials						
DB 5.1 single block, 12 mm vials	aluminum anodized	Ø 12.7 mm	20	30.0	0004469500	89.- EUR
DB 5.2 single block, 15 mm vials	aluminum anodized	Ø 15.8 mm	20	35.0	0004469600	89.- EUR
DB 5.3 single block, 17 mm vials	aluminum anodized	Ø 17.8 mm	12	45.0	0004469700	86.- EUR
DB 5.4 single block, 19 mm vials	aluminum anodized	Ø 19.7 mm	12	45.0	0004469800	86.- EUR
DB 5.5 single block, 21 mm vials	aluminum anodized	Ø 21.7 mm	9	45.0	0004469900	86.- EUR
DB 5.6 single block, 23 mm vials	aluminum anodized	Ø 23.8 mm	8	45.0	0004470000	86.- EUR
DB 5.7 single block, 25 mm vials	aluminum anodized	Ø 25.8 mm	8	45.0	0004470100	86.- EUR
DB 5.8 single block, 28 mm vials	aluminum anodized	Ø 28.8 mm	6	45.0	0004470200	86.- EUR
DB 5.9 single block, 16 mm vials	aluminum anodized	Ø 16.4 mm	15	45.0	0004470300	89.- EUR
PCR - plates, tubes, strips						
DB 6.1 single block, 10 x 8 PCR tube strips, 0.2 ml tubes	aluminum anodized	Ø 6.4 mm	80	15.5	0004470400	101.- EUR
DB 6.2 single block, 64 PCR tubes, 0.2 ml tubes	aluminum anodized	Ø 6.4 mm	64	20.2	0004470500	101.- EUR
Cuvettes						
DB 8.1 single block, 2 x 6 cuvettes, 12.5 mm	aluminum anodized			25.4	0004470700	86.- EUR
Double block (95 x 152 x 51)		Holes Ø	No. of holes	Hole depth (mm)	Ident. No.	Price
DB 7.1 double block, 96- or 384-Well-Platte	aluminum anodized	–	–	13.5	0004470800	136.- EUR
DB 6.3 double block, 1 x 96-well PCR plate, 0.2 ml tubes	aluminum anodized	Ø 6.4 mm	96	15.5	0004470600	103.- EUR
Temperature sensors				Ø	Ident. No.	Price
PT 1000.60 temperature sensor		stainless steel		2 x 3 mm	0003516800	105.- EUR
PT 1000.90 temperature sensor		stainless steel, coated with Safe Coat		2 x 3 mm	0004480600	149.- EUR

Hotplates



IKA® hotplates allow for safe heating and tempering. The set-up plate is made from glass ceramics that ensures the best possible chemical resistance. The hotplates offer a high level of safety due to a fixed safety circuit, the Hot Top indicator, and the error code display. An electronic temperature sensor may be connected for precise temperature control.



C-MAG
HP 7



Elevated control panel
for protection against
spilled liquids



Hot top indicator
to prevent burns



LED digital display
for precise temperature
setting



Ceramic set-up plate offers
excellent chemical resistance
to acid, bases and solvents



	C-MAG HP 4	C-MAG HP 7	C-MAG HP 10
Technical data			
Temperature display	digital	digital	digital
Heat output	250 W	1000 W	1500 W
Heating rate	2.5 K/min	5 K/min	5 K/min
Temperature range	50 – 500 °C	50 – 500 °C	50 – 500 °C
Setting accuracy	± 5 K	± 5 K	± 5 K
Safety circuit fixed	550 °C	550 °C	550 °C
Control accuracy with sensor	–	ETS-D5 / ± 0.5 K	ETS-D5 / ± 0.5 K
Heating plate material	ceramic	ceramic	ceramic
Weight	3 kg	5 kg	6 kg
Dimensions (W x D x H)	150 x 260 x 105 mm	220 x 330 x 105 mm	300 x 415 x 105 mm
Price	444.- EUR	519.- EUR	663.- EUR
	Ident. No. 0003581600	Ident. No. 0003581800	Ident. No. 0003582000

Heating baths



IKA® heating baths are developed with a strong focus on safety. All baths are equipped with a double jacket to protect against burns and a safety temperature monitor keeps the bath from over heating. After turning on the unit every time, the safety functions are automatically checked.

HB 10
With lock
function

HB 10

Digital
Display

LCD digital display
for precise temperature
setting



Key-button with locking
function for the heating
bath temperature



Integrated ergonomic
carrying handles



Technical data

	HB 10	HBR 4 control
Heat output	1300 W	1000 W
Temperature range	RT – 180 °C	RT – 200 °C
Setting tolerance	± 1 K	± 1 K
Deviation (3 l H ₂ O, 90 °C)	± 1 K	± 1 K
Temperature display	digital	digital
Volume	3 l	4 l
Safety class acc. to DIN 12877	II	II
Adjustable safety circuit min / max	50 °C / 190 °C	50 °C / 210 °C
Material	stainless steel 1.4404	stainless steel 1.4301
Weight	3 kg	4.4 kg
Dimensions (W x D x H)	295 x 265 x 190 mm	340 x 340 x 250 mm
Interface	no	RS 232
ext. Sensor	no	yes

Price

1,474.- EUR

3,131.- EUR

Ident. No. 0004068000

Ident. No. 0020003549*

* PT 1000.60 temperature sensor included.

HBR 4 accessories

	Ident. No.	Price
H 240	0002858700	445.- EUR
Ring set		
H 159	0001809700	203.- EUR
Intermediate bottom		



Temperature Control



Temperature Control Products

Watch the video now:
www.ika.com/video



Energy-efficient recirculating chillers!

- > Robust stainless steel housing
- > Visible fluid level display
- > Large funnel for easy refill
- > Overflow at the rear of the device
- > Visual and acoustic alarm

Removable wireless controller (WiCo) for convenient and user-friendly operation!



RC 2 control



Connection for PT 100 temperature probe



Large operating volume



The speed-regulated compressor provides better temperature stability of up to ± 0.05 K



Detachable wireless controller (WiCo) for simple and safe remote access from up to 10 m (30 ft.)

IKA® offers a wide range of high-precision temperature control systems according to DIN 12876 for temperature ranges of -20°C to 250°C . The product portfolio includes immersion circulators, heating bath circulators and recirculating chillers. Precise technology and user-friendly design make temperature control easy for any application. All IKA® temperature control instruments meet the highest standards in terms of safety, power and intelligence. In addition, IKA® provides a wide range of accessories for its temperature control systems such as baths, bridges, thermal fluids and much more.

Temperature Control

ICC basic & control



Integrated pressure / suction pump for internal and external temperature control



USB / RS 232 interfaces for connecting a PC, using labworldsoft® and enabling online updates of device software

ICC basic & control



Integrated PT 100 interface



ICC basic | control

Technical data

Appliance type	Compact immersion circulator
Heater capacity (230 / 115 V)	2000 / 1000 W
Temperature range	RT +10 °C – 150 °C
Temperature display	LED TFT
Temperature stability DIN 12876	± 0.02 K ± 0.01 K
Max. flow rate (at 0 bar)	18 l/min
Max. pump pressure	0.3 bar
Min. suction pressure	0.2 bar
Dimensions (W x D x H)	145 x 200 x 340 mm
USB / RS 232 interface	yes
PT 100 interface	no yes

893.- EUR | 1,392.- EUR

Ident. No. 0004134400

Ident. No. 0004136600

IC control



Integrated pressure and suction pump allows flexibility for internal and external applications



Flexible bath bridge enables easy mounting on different water bath sizes



Large easy-to-read TFT display



Removable wireless controller (WiCo) for easy and safe operation up to 10 m



IC basic | control

Technical data

Appliance type	Immersion circulator
Heater capacity (230 / 115 V)	2500 / 1250 W
Temperature range	RT +10 °C – 200 °C* RT +10 °C – 250 °C*
Temperature display	LED TFT
Temperature stability DIN 12876	± 0.02 K ± 0.01 K
Max. flow rate (at 0 bar)	26 l/min 31 l/min
Max. pump pressure	0.45 bar 0.61 bar
Min. suction pressure	0.35 bar 0.45 bar
Dimensions (W x D x H)	285 x 291 x 313 mm
USB / RS 232 interface	yes
PT 100 interface	yes

Price

2,100.- EUR | 2,750.- EUR

Ident. No. 0003861000

Ident. No. 0003863000**

* Possible operating temperatures with cooling coil: -20 – 200/250 °C.

** CC 1 cooling coil included in delivery

Temperature Control | Packages

IKA+

Eco baths (plastic) can be used at temperatures of up to 100 °C (H₂O only). Pro baths (stainless steel) can be used at temperatures of up to 200 °C.

Included in ICC Package 1:

- ① ICC basic/control head
- ② Bath bridge
- ③ Bath vessel



Additionally included in ICC Package 2:

- ④ Cover
- ⑤ Cooling coil
- ⑥ Pump connection set
- ⑦ PT 100 probe (control version only)

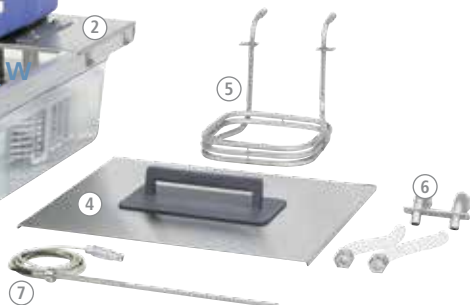

IC Package Included:

- ① IC basic/control head
- ② Bath bridge
- ③ Bath vessel
- ④ Cover
- ⑤ PT 100 probe
- ⑥ Cooling coil*

* Already included with control devices



ICC basic eco 8



ICC control pro 20 c



IC basic pro 12 c



ICC eco 18

Description	Package	Bath size	Bath opening (W x D)*	Ident. No.	Price
ICC Package 1					
Includes:	ICC basic eco 8		188 x 105	0008034900	1,215.- EUR
> ICC circulator	ICC control eco 8	S		0008035300	1,714.- EUR
> Bath	ICC basic pro 9		195 x 100	0008035100	1,340.- EUR
> Bath bridge	ICC control pro 9			0008035500	1,839.- EUR
	ICC basic pro 12	M	255 x 127	0010000414	1,402.- EUR
	ICC control pro 12			0010000415	1,890.- EUR
	ICC basic eco 18		245 x 305	0008035000	1,329.- EUR
	ICC control eco 18	L		0008035400	1,828.- EUR
	ICC basic pro 20		255 x 309	0008035200	1,485.- EUR
	ICC control pro 20			0008035600	1,984.- EUR

Description	Package	Bath size	Bath opening (W x D)*	Ident. No.	Price
ICC Package 2					
Includes:	ICC basic eco 8 c		188 x 105	0008035700	1,516.- EUR
> ICC circulator	ICC control eco 8 c	S		0008036100	2,265.- EUR
> Bath	ICC basic pro 9 c		195 x 100	0008035900	1,662.- EUR
> Bath bridge	ICC control pro 9 c			0008036300	2,410.- EUR
> Cover	ICC basic pro 12 c	M	255 x 127	0010000416	1,735.- EUR
> Pump connection set	ICC control pro 12 c			0010000417	2,483.- EUR
> Cooling coil	ICC basic eco 18 c		245 x 305	0008035800	1,662.- EUR
> PT 100.30 (control version only)	ICC control eco 18 c	L		0008036200	2,400.- EUR
	ICC basic pro 20 c		255 x 309	0008036000	1,828.- EUR
	ICC control pro 20 c			0008036400	2,576.- EUR

Description	Package	Bath size	Bath opening (W x D)*	Ident. No.	Price
IC Package					
Includes:	IC basic pro 12 c	M	255 x 80	0008039900	3,044.- EUR
> IC circulator	IC control pro 12 c			0008040000	3,490.- EUR
> Bath	IC basic pro 20 c			0008036800	3,168.- EUR
> Bath bridge	IC control pro 20 c	L	255 x 262	0008037200	3,570.- EUR
> Cover					
> Cooling coil**					
> PT 100.30					

* Size of plate that can be set at the bottom of the bath

** Already included in IC control device

Immersion depth for all baths with ICC: 85 mm to 125 mm;
IC: 95 mm to 135 mm

Package details
on page 172

Temperature Control



	HBC 5 basic control	HBC 10 basic control	RC 2 basic control
Technical data			
Appliance type	Heating bath circulator	Heating bath circulator	Recirculating chiller
Safety class	III (FL)	III (FL)	I (NFL)
Cooling capacity at 20 °C	–	–	400 W
Heater capacity (230 / 115 V)	2500 / 1250 W	2500 / 1250 W	–
Temperature range	RT +10 °C – 200 °C RT +10 °C – 250 °C (cooling coil integrated*)	RT +10 °C – 200 °C RT +10 °C – 250 °C (cooling coil integrated*)	-20 °C – RT
Temperature display	LED TFT	LED TFT	LED TFT
Temperature stability DIN 12876	± 0.02 K ± 0.01 K	± 0.02 K ± 0.01 K	± 0.1 K ± 0.05 K
Bath volume range	5.5 – 7.5 l	7.5 – 10.5 l	1.5 – 4 l
Max. flow rate (at 0 bar)	26 l/min 31 l/min	26 l/min 31 l/min	18 l/min
Max. pump pressure	0.45 bar 0.61 bar	0.45 bar 0.61 bar	0.3 bar
Min. suction pressure	0.35 bar 0.45 bar	0.35 bar 0.45 bar	0.2 bar
Dimensions (W x D x H)	275 x 500 x 405 mm	275 x 506 x 456 mm	220 x 525 x 475 mm
Permissible ambient temperature	5 – 40 °C	5 – 40 °C	5 – 32 °C
Permissible relative moisture	80%	80%	80%
Protection class acc. to DIN EN 60529	IP 21	IP 21	IP 21
USB / RS 232 interface	yes	yes	yes
PT 100 interface	yes	yes	no yes
Price	2,750.- EUR 3,250.- EUR	2,820.- EUR 3,400.- EUR	2,950.- EUR 3,450.- EUR
	Ident. No. 0004125000 Ident. No. 0004127000	Ident. No. 0004135000 Ident. No. 0004137000	Ident. No. 0004171000 Ident. No. 0004173000

* Possible operating temperatures with cooling coil: -20 – 200/250 °C.

HBC 5
control



Integrated pressure / suction pump allows flexibility for internal and external applications



Integrated handles for easy carrying



Precise temperature stability ± 0.01 K



Optical and acoustic warning function e.g. for over heating



Removable wireless controller (WiCo) for easy and safe operation up to 10 m



DESIGN
AWARD
2015



basic and control interfaces

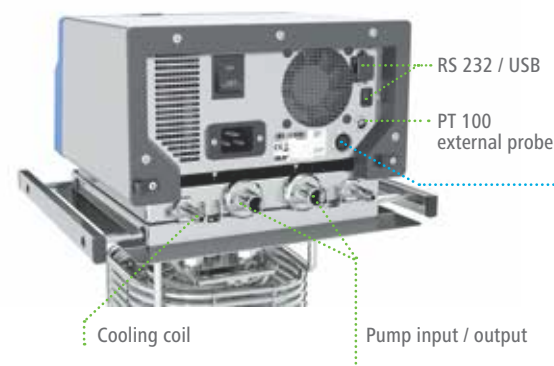

Option to connect external solenoid valves via multi I/O port (IC / HBC control only)

- > For the control of solenoid valves
 - For automatic refilling
 - For switching the cooling water circuit on/off
 - For fluid level monitoring
 - As an electronic stopcock
- > Output for alarm signals
- > Input for standby mode (for switching off the device)



Temperature Control | Accessories

Bath vessels

Ident. No. Price



IB 8 eco* 0004248100 291.- EUR

Bath vessel, plastic, 8 l, size S



IB 18 eco* 0004248200 410.- EUR

Bath vessel, plastic, 18 l, size L



IB HF 24 eco* 0020006884 467.- EUR

Bath vessel, plastic, 24 l, size L

IB 9 pro 0004248500 410.- EUR

Bath vessel, stainless steel, 9 l, size S



IB 12 pro 0004577500 468.- EUR

Bath vessel, stainless steel, 12 l, size M



IB 20 pro 0004248600 563.- EUR

Bath vessel, stainless steel, 20 l, size L



IB R RO15 eco* 0020006341 727.- EUR

Bath vessel for magn. stirrer RO 15, size L



IB R 9 eco* 0020004382 311.- EUR

Bath vessel, 31 x 24 x 15, plastic, rectangular, size S

IB R 20 eco* 0020004383 415.- EUR

Bath vessel, 50 x 31 x 15, plastic, rectangular, size L

IB R 52 eco* 0020007044 571.- EUR

Bath vessel, 60 x 31 x 30, plastic, rectangular, size L

ICC accessories

Ident. No. Price



CS.ICC 0004471500 115.- EUR

Cover, small for ICC, for bath vessels size S

CM.ICC 0025000290 146.- EUR

Cover, medium for ICC, for bath vessels size M



CL.ICC 0004471600 146.- EUR

Cover, big for ICC, for bath vessels size L



BS.ICC 0020003077 111.- EUR

Bridge, small for ICC, for bath vessels size S

BL.ICC 0020003078 111.- EUR

Bridge, big for ICC, for bath vessels size M & L

CC2 0025001061 109.- EUR

Cooling coil for ICC



PCS.ICC 0004471900 127.- EUR

Pump connection set for ICC

IC accessories

Ident. No. Price



CM.IC 0004577600 111.- EUR

Cover, medium for IC, for bath vessels size M



CL.IC 0004471800 146.- EUR

Cover, big for IC, for bath vessels size L



BS.IC 0004472800 111.- EUR

Bridge, small for IC, for bath vessels size M & L



CC1 0020005116 116.- EUR

Cooling coil for IC basic + control

* Maximum temperature eco baths 100 °C, water.

Temperature Control | Accessories

Therموfluids

	Ident. No.	Price
HF.Si.20.250.50A	0020003521	355.- EUR

Heating fluid Si250A; 10 kg

HF.Si.20.200.50	0020003520	333.- EUR
-----------------	------------	-----------

Heating fluid Si200; 10 kg



UF.Si.N30.150.10LV	0020003518	333.- EUR
--------------------	------------	-----------

Universal fluid Si150 LV; 9 kg

Hoses

	Ident. No.	Price
--	------------	-------



LT 5.20	0002606700	991.- EUR
---------	------------	-----------

Hose, insulated, stainless steel, Ø 10 mm, 1.5 m, 2 pcs.

LT 5.21	0020000988	780.- EUR
---------	------------	-----------

Hose, insulated, PTFE, Ø 13 mm, 1.5 m, 2 pcs.

H.PVC.8	0004568800	10.- EUR
---------	------------	----------

Hose, PVC, Ø 8 mm, 1.5 m, 2 pcs.

H.PVC.12	0004568900	13.- EUR
----------	------------	----------

Hose, PVC, Ø 12 mm, 1.5 m, 2 pcs.



H.SI.8	0004569000	26.- EUR
--------	------------	----------

Hose, silicone, Ø 8 mm, 1.5 m, 2 pcs.

H.SI.12	0004569100	32.- EUR
---------	------------	----------

Hose, silicone, Ø 12 mm, 1.5 m, 2 pcs.



H.PUR.8.R	0020004612	49.- EUR
-----------	------------	----------

Hose, PUR, Ø 8 mm, 1.5 m, 2 pcs.

H.PUR.12	0020004613	60.- EUR
----------	------------	----------

Hose, PUR, Ø 12 mm, 1.5 m, 2 pcs.



H.FKM.8	0004569200	249.- EUR
---------	------------	-----------

Hose, FKM, Ø 8 mm, 1.5 m, 2 pcs.

H.FKM.12	0004569300	305.- EUR
----------	------------	-----------

Hose, FKM, Ø 12 mm, 1.5 m, 2 pcs.

Insulation for hoses

	Ident. No.	Price
--	------------	-------



ISO.8	0004569400	21.- EUR
-------	------------	----------

Insulation, for hoses DN 8



ISO.12	0004569500	28.- EUR
--------	------------	----------

Insulation, for hoses DN 12

Tube racks

	Ident. No.	Price
--	------------	-------



Tube rack, 13 mm, S, stainless	0020004026	72.- EUR
--------------------------------	------------	----------

Stainless steel rack for bath size S, 57 x Ø 13 mm

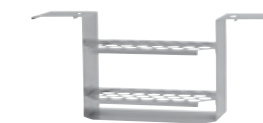

Tube rack, 17 mm, S, stainless	0020004027	72.- EUR
--------------------------------	------------	----------

Stainless steel rack for bath size S, 37 x Ø 17 mm

Tube rack, 22 mm, S, stainless	0020004028	72.- EUR
--------------------------------	------------	----------

Stainless steel rack for bath size S, 22 x Ø 22 mm

Tube rack, 13 mm, ML, stainless	0020004029	121.- EUR
---------------------------------	------------	-----------

Stainless steel rack for bath size L, 73 x Ø 13 mm

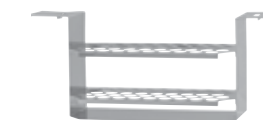

Tube rack, 17 mm, ML, stainless	0020004030	121.- EUR
---------------------------------	------------	-----------

Stainless steel rack for bath size L, 47 x Ø 17 mm



Tube rack, 22 mm, ML, stainless	0020004031	121.- EUR
---------------------------------	------------	-----------

Stainless steel rack for bath size L, 30 x Ø 22 mm

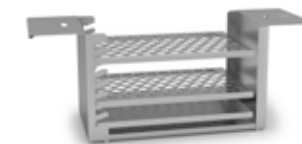

Variable rack, ICC, ML, stainless	0020004032	155.- EUR
-----------------------------------	------------	-----------

Variable Rack for baths size M+L.ICC

Inlay 1, variable rack, ICC, ML	0020004033	51.- EUR
---------------------------------	------------	----------

Bottom type 1 for variable rack, 2 pcs., for 84 tubes with Ø 13 mm

Inlay 2, variable rack, ICC, ML	0020004034	51.- EUR
---------------------------------	------------	----------

Bottom type 2 for variable rack, 2 pcs., for 51 tubes with Ø 17 mm

Inlay 3, variable rack, ICC, ML	0020004035	51.- EUR
---------------------------------	------------	----------

Bottom type 3 for variable rack, 2 pcs., for 33 tubes with Ø 22 mm



Variable bottom, ICC, L, stainless	0020004614	363.- EUR
------------------------------------	------------	-----------

Variable bottom for baths size L.ICC



Bottom plate L	0020006212	375.- EUR
----------------	------------	-----------

Bottom plate for baths size L

Bottom plate L, ICC	0020007353	315.- EUR
---------------------	------------	-----------

Bottom plate for baths size L.ICC

Temperature Control | Accessories

Floating racks

Ident. No. Price

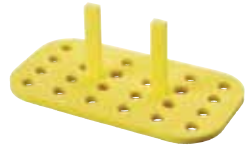

Floating tube rack 1 0020003667 27.- EUR

Floating tube rack for 24 x 1.5/2.0 ml tubes, 5 pcs.

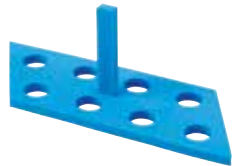

Floating tube rack 2 0020003668 27.- EUR

Floating tube rack for 8 x 15 ml tubes, 5 pcs.



Floating tube rack 3 0020003669 27.- EUR

Floating tube rack for 4 x 50 ml tubes, 5 pcs.

Magnetic valves

Ident. No. Price

MV 1 0020003763 348.- EUR

Magnetic valve for cooling water control, max.100 °C



CO V 1 0020000249 528.- EUR

Closed pressure valve for external pump connection Set, max. 180 °C



Ball valve M 16 x 1 0020004620 104.- EUR

Ball valve, complete open (M 16 x 1)



Mechanic fluid level controller 0020004618 360.- EUR

Mechanic fluid level controller

Adapters

Ident. No. Price



Elbow tube 90° 0025001212 66.- EUR

Elbow tube 90°



Olive for DN 6 hoses 0020004667 35.- EUR

Olive for DN 6 hoses 2 pcs.



Olive for DN 8 hoses 0020004566 35.- EUR

Olive for DN 8 hoses 2 pcs.



Olive for DN 12 hoses 0020004889 35.- EUR

Olive for DN 12 hoses 2 pcs.



Olive for DN 10 hoses 0020004568 35.- EUR

Olive for DN 10 hoses 2 pcs.



Adapter NPT 1/4 0020004569 35.- EUR

Adapter M 16 to NPT 1/4 2 pcs.



Adapter NPT 1/2 0020004570 111.- EUR

Adapter M 16 to NPT 1/2 2 pcs.



Adapter NPT 3/4 0020004571 132.- EUR

Adapter M 16 to NPT 3/4 2 pcs.

Lock nut (2 pcs.) 0020004583 33.- EUR

Lock nut 2 pcs.

Stopper (2 pcs.) 0020004584 33.- EUR

Stopper 2 pcs.

Additional accessories

Ident. No. Price



WH10 0020000984 16.- EUR

WiCo holder



PT 100.30 0004284700 263.- EUR

Temperature sensor, stainless steel



Floating globes, PP 0020003666 99.- EUR

Floating globes, PP, 500 pcs.

Centrifuge



The IKA® microcentrifuge is ideal for applications which do not require ultra high speeds e.g., micro-filtrations and cell separations. The centrifuge features a compact design and a small footprint. A transparent lid allows for constant observation of the centrifuge which can be used with both microcentrifuge and PCR strip tubes. As a safety feature, the IKA® mini G will only operate when the lid is closed.

**IKA®
mini G**

Integrated quick stop



Rotor exchangeable without tools



Adjustable digital timer



Quiet operation



Special safety features



Touch keypad for easy operation



Technical data

Capacity	8 x 2.0 ml
Permitted density	1.2 kg / dm ³
Centrifugal acceleration	2000 G
Max. kinetic energy	20 Nm
Motor rating input / output	12 / 8 W
Fixed speed	6000 rpm
Reversible direction of rotation	no
Dimensions (W x D x H)	155 x 175 x 105 mm
Weight	1.4 kg

Price

IKA® mini G

Capacity	8 x 2.0 ml
Permitted density	1.2 kg / dm ³
Centrifugal acceleration	2000 G
Max. kinetic energy	20 Nm
Motor rating input / output	12 / 8 W
Fixed speed	6000 rpm
Reversible direction of rotation	no
Dimensions (W x D x H)	155 x 175 x 105 mm
Weight	1.4 kg

296.- EUR

Ident. No. 0003958000

Accessories included in the delivery

Ident. No.

1	Rotor 8 x 1.5 / 2 ml	0003918500
2	Rotor 4 x strip 8 x 0.2 ml	0004531300
3	Adapter set 0.5 ml x 8	0004470900
4	Adapter set 0.4 ml x 8	0004470901
5	Adapter set 0.2 ml x 8	0004470902



Rotary Evaporators



MAGIC DISTILLATION

Watch the video now:
www.ika.com/video



IKA® rotary evaporators set new standards for safety, efficiency and ease of use. These products offer excellent distilling solutions. All IKA® RV 10 evaporators are equipped with an automated lift including a safety stop function. More safety features are: interval operation, smooth start, end position recognition, automated lift-out in case of power outage as well as a timer function.



Efficient & safe distillation!

- > Automated management of cooling water
- > Automated ventilation after end of experiment
- > Automated control of heating bath during experiment

Patented

Volume controlled distillation!

RV 10
control
auto

240
58.4 °C

Two digital displays for an optimal overview



Compatible with the complete range of IKA® RV 10 glassware



Can be moved by 140 mm to accommodate different flasks



Adjustable immersion angle and height



Rotary Evaporators

Best-in-class
cooling surface
1500 cm²

V: Rotary evaporator with set of vertical glassware
V-C: Rotary evaporator with set of vertical coated glassware
FLEX: Rotary evaporator without any glassware (condenser, evaporation and receiving flask); either use pre-existing IKA® glassware or order separately



The RV 8 offers an effortless manually supported lifting mechanism. The ambidextrous design makes working more convenient and comfortable.

RV 8

Drive

Motor type	brushless DC drive motor
Motor rating input	50 W
Speed range	5 – 300 rpm
Speed display	digital
Clockwise and counter-clockwise	no
Soft start	yes
Head angle adjustable	0 to 45°
Stroke displacement	120 mm, manual
Setting of lower end stop	no
Vacuum controller	optional

General data

Dimensions (W x D x H)	495 x 390 x 615 mm
Weight of the drive incl. heating bath without glass parts	17.2 kg
Permissible ambient temperature	5 to 40 °C
Permissible relative moisture	80%
Protection class according to DIN EN 60529	IP 20
Voltage / Frequency	220 – 240 V / 50/60 Hz

Price

2,349.- EUR | 2,481.- EUR | 2,224.- EUR

RV 8 V Ident. No. 0010002170

RV 8 V-C Ident. No. 0010002173

RV 8 FLEX Ident. No. 0010002166



Compatible with the complete range of IKA® glassware

RV 8



Adjustable immersion angle and height



Can be moved by 120 mm to accommodate different flasks



Heating bath can be used as a stand-alone unit and has integrated ergonomic carrying handles



Push-out function:

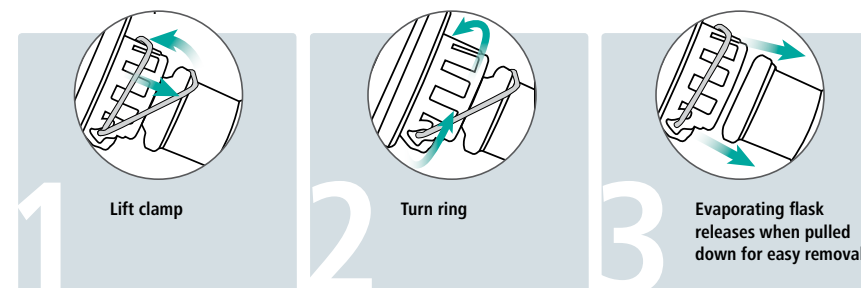

Accessories starting page 132 – 137

Rotary Evaporators



Watch the video now:
www.ika.com/video



V: Rotary evaporator with set of vertical glassware
V-C: Rotary evaporator with set of vertical coated glassware
FLEX: Rotary evaporator without any glassware (condenser, evaporation and receiving flask); either use pre-existing IKA® glassware or order separately



RV 10 digital

Drive

Motor type	brushless DC drive motor
Motor rating input	50 W
Speed range	5 – 280 rpm
Speed display	digital
Clockwise and counter-clockwise	yes
Soft start	yes
Head angle adjustable	0 to 45°
Stroke displacement	140 mm, motorized
Setting of lower end stop	60 mm, contact free
Vacuum controller	optional

General data

Dimensions (W x D x H)	500 x 410 x 430 mm
Weight of the drive incl. heating bath without glass parts	20 kg
Permissible ambient temperature	5 to 40 °C
Permissible relative moisture	80%
Protection class according to DIN EN 60529	IP 20
Voltage / Frequency	220 – 240 V / 50/60 Hz

Price

3,477.- EUR | 3,767.- EUR | 2,606.- EUR

* RV 10.4002 magnetic valve now included with delivery of every RV 10 control V, V-C and FLEX package

RV 10 digital V Ident. No. 0008040300
 RV 10 digital V-C Ident. No. 0008040400
 RV 10 digital FLEX Ident. No. 0008040500



if product design award 2009

RV 10 control

brushless DC drive motor
50 W
5 – 280 rpm
digital
yes
yes
0 to 45°
140 mm, motorized
60 mm, contact free
integrated

530 x 410 x 430 mm
21.5 kg
5 to 40 °C
80%
IP 20
220 – 240 V / 50/60 Hz

4,869.- EUR | 5,174.- EUR | 3,955.- EUR
 7,387.- EUR | 7,656.- EUR | 6,119.- EUR

RV 10 control V Ident. No. 0008037700*
 RV 10 control V-C Ident. No. 0008037900*
 RV 10 control FLEX Ident. No. 0008038100*
 RV 10 control V auto Ident. No. 0008037800
 RV 10 control V-C auto Ident. No. 0008038000
 RV 10 control FLEX auto Ident. No. 0008038200

Automatic boiling point detection



RV 10 control

With the integrated vacuum controller and magnetic valve (included) the customer can work with any vacuum source, or other single vacuum pump (see page 127)

RV 10 control auto

The enhanced RV 10 control is now equipped with our fully automated speed control pump N 920. Additionally, the RV 10 control auto detects the required level of vacuum pressure by detecting the boiling point of the solvent. This feature has some significant benefits over a valve-regulated system.

Advantages:

- > Increased solvent recovery performance up to 100%
- > Automatic boiling point detection
- > Speed controlled vacuum pump for precise vacuum level
- > Reduced noise level and wearing of pump components
- > Reduced process time and increased overall performance

Accessories starting page 132 – 137

Rotary Evaporators | Accessories



RV 10 / RV 8 accessories
Glassware

Ident. No. Price

RV 10.1 0003655300 699.- EUR

Set of glassware, vertical

RV 10.10 0003755400 982.- EUR

Set of glassware, vertical, coated



RV 10.2 0003755300 721.- EUR

Set of glassware, diagonal

RV 10.20 0003755500 999.- EUR

Set of glassware, diagonal, coated



Condensers

RV 10.3 0003741000 840.- EUR

Vertical-intensive condenser, manifold

RV 10.30 0003741100 1,150.- EUR

Vertical-intensive condenser, manifold, coated



RV 10.4 0003742000 1,219.- EUR

Dry ice condenser

RV 10.40 0003742100 1,350.- EUR

Dry ice condenser, coated



RV 10.5 0003743000 1,349.- EUR

Vertical-condenser, reflux

RV 10.50 0003743100 1,480.- EUR

Vertical-condenser, reflux, coated



RV 10.6 0003744000 1,482.- EUR

Vertical-intensive condenser, reflux

RV 10.60 0003744100 1,615.- EUR

Vertical-intensive condenser, reflux, coated



Evaporation cylinders

RV 10.400 0003738800 551.- EUR

Evaporation cylinder, NS 29/32, 500 ml

RV 10.401 0003738900 629.- EUR

Evaporation cylinder, NS 29/32, 1500 ml



Bump trap

RV 10.500 0003739200 117.- EUR

Foam brake, NS 29/32



Distilling spider with distilling sleeves

RV 10.600 0003739400 471.- EUR

Distilling spider, NS 29/32, 6 sleeves

RV 10.601 0003739500 789.- EUR

Distilling spider, NS 29/32, 12 sleeves

RV 10.602 0003739600 1,106.- EUR

Distilling spider, NS 29/32, 20 sleeves

RV 10.610 0003919400 13.- EUR

Distilling sleeve, 20 ml



Distilling spider with 5 flasks

RV 10.606 0003740800 575.- EUR

Distilling spider with 5 flasks, 50 ml

RV 10.607 0003740900 630.- EUR

Distilling spider with 5 flasks, 100 ml



Rotary Evaporators | Accessories



Evaporation flasks

	Ident. No.	Price
RV 10.80	0003740100	27.- EUR
Evaporation flask, NS 29/32, 50 ml		
RV 10.800	0020005330	55.- EUR
Evaporation flask, coated, NS 29/32, 50 ml		
RV 10.81	0003740200	27.- EUR
Evaporation flask, NS 29/32, 100 ml		
RV 10.810	0020005331	55.- EUR
Evaporation flask, coated, NS 29/32, 100 ml		
RV 10.82	0003740300	51.- EUR
Evaporation flask, NS 29/32, 250 ml		
RV 10.820	0020005332	103.- EUR
Evaporation flask, coated, NS 29/32, 250 ml		
RV 10.83	0003740400	54.- EUR
Evaporation flask, NS 29/32, 500 ml		
RV 10.830	0020005333	108.- EUR
Evaporation flask, coated, NS 29/32, 500 ml		
RV 10.84	0003740500	55.- EUR
Evaporation flask, NS 29/32, 1000 ml		
RV 10.840	0004221400	112.- EUR
Evaporation flask, coated, NS 29/32, 1000 ml		

IKA®+

All evaporation flasks are available as a special temperature coated version (for usage at max. 180°C in a heating bath)

RV 10.85	0003740600	87.- EUR
Evaporation flask, NS 29/32, 2000 ml		
RV 10.850*	0020005334	174.- EUR
Evaporation flask, coated, NS 29/32, 2000 ml		
RV 10.86	0003740700	134.- EUR
Evaporation flask, NS 29/32, 3000 ml		
RV 10.860	0020005335	268.- EUR
Evaporation flask, coated, NS 29/32, 3000 ml		
RV 10.90	0003741200	13.- EUR
Evaporation flask, NS 24/29, 50 ml		
RV 10.91	0003741300	16.- EUR
Evaporation flask, NS 24/29, 100 ml		



Powder flasks

	Ident. No.	Price
RV 10.300	0003738200	126.- EUR
Powder flask, NS 29/32, 500 ml		
RV 10.301	0003738300	136.- EUR
Powder flask, NS 29/32, 1000 ml		
RV 10.302	0003738400	168.- EUR
Powder flask, NS 29/32, 2000 ml		



Receiving flasks

	Ident. No.	Price
RV 10.100	0003742200	48.- EUR
Receiving flask, KS 35/20, 100 ml		
RV 10.101	0003742300	49.- EUR
Receiving flask, KS 35/20, 250 ml		
RV 10.102	0003742400	52.- EUR
Receiving flask, KS 35/20, 500 ml		
RV 10.103	0003742500	55.- EUR
Receiving flask, KS 35/20, 1000 ml		
RV 10.104	0003742600	89.- EUR
Receiving flask, KS 35/20, 2000 ml		
RV 10.105	0003742700	169.- EUR
Receiving flask, KS 35/20, 3000 ml		
RV 10.200	0003743200	94.- EUR
Receiving flask, coated, KS 35/20, 100 ml		
RV 10.201	0003743300	98.- EUR
Receiving flask, coated, KS 35/20, 250 ml		
RV 10.202	0003743400	121.- EUR
Receiving flask, coated, KS 35/20, 500 ml		
RV 10.203	0003743500	144.- EUR
Receiving flask, coated, KS 35/20, 1000 ml		
RV 10.204	0003743600	161.- EUR
Receiving flask, coated, KS 35/20, 2000 ml		
RV 10.205	0003743700	214.- EUR
Receiving flask, coated, KS 35/20, 3000 ml		

Vapor tubes, seals and other accessories

	Ident. No.	Price
RV 10.70	0003812200	86.- EUR
Vapor tube, NS 29/32		
RV 10.74	0003971700	73.- EUR
Vapor tube, short, NS 29/32		
RV 10.8001	0003907000	92.- EUR
Seal, PTFE, stainless steel		
RV 10.3000	0003859000	117.- EUR
Extension plate for use with RV 10.500 foam break and 3 l evaporation flask		

HB 10 heating bath accessories

	Ident. No.	Price
HB 10.1	0003641800	161.- EUR
Shield for heating bath HB 10		
HB 10.2	0003641000	484.- EUR
Protection cover for heating bath HB 10		

Rotary Evaporators | Accessories

Vacuum pumps

Ident. No. Price



MVP 10 basic 0003980000 1,404.- EUR

Membrane vacuum pump for dry, oil-free applications in the low vacuum range



N 920 KT.29.18 0003919100 1,892.- EUR

Membrane vacuum pump



SC 920 D400 0004583600 4,852.- EUR

Vacuum pump



LVS 105T-10 ef 0004067800 3,345.- EUR

Vacuum pump

MVP 10 basic accessories

Ident. No. Price



VCV 1 0020004850 495.- EUR

Vacuum control valve manual



VCV 2 0020004893 821.- EUR

Vacuum control valve digital



VSS 1 0020005194 694.- EUR

Vacuum safety set

RV 10 control accessories

Vacuum pump valves

Ident. No. Price



RV 10.4001 0003902600 449.- EUR

Magnetic valve in-house vacuum



RV 10.4002 0003880300 556.- EUR

Magnetic valve laboratory vacuum



RV 10.4003 0003900200 1,057.- EUR

Pump control including magnetic valve



RV 10.5001 0003902700 442.- EUR

Choke water valve, for RV 10 series

RV 8 accessories

Ident. No. Price



RV 8.1 0004438500 86.- EUR

Support Pole



RV 8.2 0025001342 44.- EUR

Mechanical end stop for RV 8

Accessories for all IKA® rotary evaporator models

Ident. No. Price

RV 05.10 0000736600 15.- EUR

Balljoint clamp

RV 10.88 0003683300 15.- EUR

Clamp, NS 29

RV 10.5005 0020000552 86.- EUR

Hose kit



RV 10.5002 0003903800 55.- EUR

Filter, for RV 10 and RV 8 series



RV 10.5003 0003907100 175.- EUR

Pressure regulating valve, for RV 10 and RV 8 series

Mechanical / Electronic accessories



Support stand details on page 140

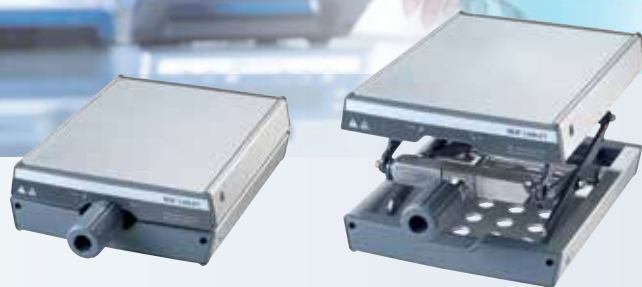

Lifts

LABLIFT m 0004022400 227.- EUR

Manual scissors lift, set-up plate dimensions 170 x 230 mm, stroke 70 – 300 mm, max. dynamic load 7 kg



Mechanical accessories | Fixing clamps

	Ident. No.	Price
① H 44	0002437700	23.- EUR
Boss head clamp, clamping range Ø 10 – 11 mm, for stand R 104		
② R 200	0003372000	27.- EUR
Clamp for disperser T 10 basic and stand R 104		
③ R 182	0002657700	67.- EUR
Boss head clamp, clamping range Ø 6 – 16 mm, for stands R 1825, R 1826, R 1827		
④ R 270	0002657800	90.- EUR
Boss head clamp, clamping range Ø 25 – 36 mm, for stands R 2722 and R 2723		
⑤ R 271	0002664000	147.- EUR
Boss head clamp, clamping range Ø 34 mm, for stands R 2722 and R 2723		
⑥ R 350	0001752900	84.- EUR
Universal clamp, for use with H 44 & R 104 or R 181 & R 1825, R 1826, R 1827		
⑦ RH 3	0003008600	224.- EUR
Strap clamp for stand Ø 8 – 16 mm, for stands R 104, R 1825, R 1826 and R 1827		
⑧ RH 5	0003159000	280.- EUR
Strap clamp for stand Ø 25 – 36 mm, for stands R 2722 and R 2723		



Electronic accessories

	Ident. No.	Price
⑨ ALMEMO 2490	0004709300	1,467.- EUR
The ALMEMO 2490 is a universal measuring device with 2 measuring channels. Especially adopted for the requirements of either simple temperature measuring purposes or as an accessory for our lab reactors to measure and display temperature and/or pH.		
ALMEMO accessories		
	Ident. No.	Price
ALMEMO	0004709400	298.- EUR
USB cable		
PC 1.2	0002616800	48.- EUR
Adapter, 25 pins		
⑩ DTM 12.10	0003127800	270.- EUR
Data cable, L2.5 m, 9 pins (F)		
⑪ PT 100.23	0003122100	242.- EUR
Temperature sensor, stainless steel, Ø 3 mm, 250 mm length		
⑫ PT 100.24	0003122200	247.- EUR
Temperature sensor, stainless steel, glass-coated, Ø 8 mm, 250 mm length		
⑬ PT 100.25	0003122300	198.- EUR
Temperature sensor, stainless steel, Ø 6 mm, 255 mm length		
LR 2000.64	0020010075	931.- EUR
pH process electrode		

Mechanical accessories

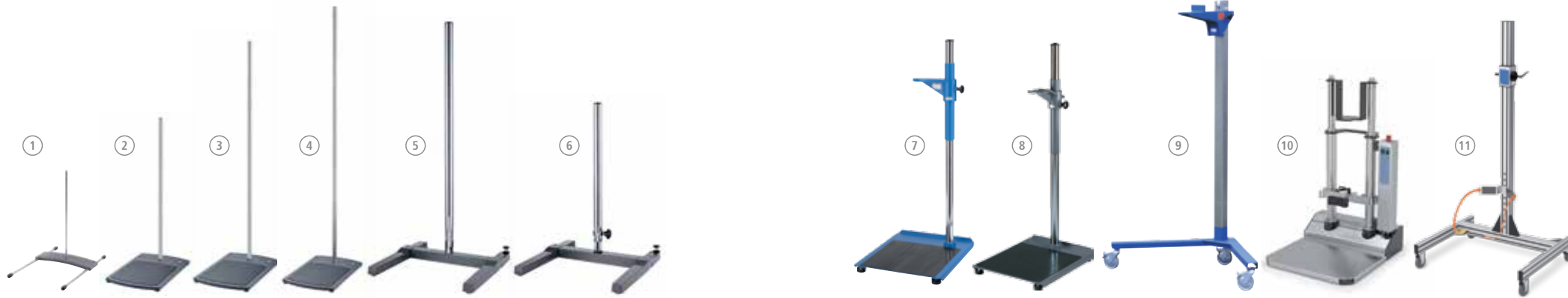

Stands

		Diameter of support rod	Dimensions (W x D)	Height	Suitable accessories (clamps)*	Max. load	Stroke	Ident. No.	Price
①	R 104 stand Stand for T 10 basic, H 370 mm	10 mm	242 x 355 mm	370 mm	H 44, RH 3	0.7 kg	–	0003386000	128.- EUR
②	R 1825 plate stand Plate stand, H 560 mm	16 mm	200 x 316 mm	560 mm	R 182, RH 3	5 kg	–	0003160000	222.- EUR
③	R 1826 plate stand Plate stand, H 800 mm	16 mm	200 x 316 mm	800 mm	R 182, RH 3	5 kg	–	0003160100	245.- EUR
④	R 1827 plate stand Plate stand, H 1000 mm	16 mm	200 x 316 mm	1000 mm	R 182, RH 3	5 kg	–	0003160200	265.- EUR
⑤	R 2722 H-stand H-stand, H 1010 mm	34 mm	460 x 420 mm	1010 mm	R 270, R 271, RH 5	10 kg	–	0001412000	571.- EUR
⑥	R 2723 telescopic stand Telescopic stand, H 620 – 1010 mm	34 mm	460 x 420 mm	620 – 1010 mm	R 270, R 271, RH 5	10 kg	390 mm	0001412100	1,123.- EUR
⑦	T 653 telescopic stand Telescopic stand, H 1200 mm	48 mm	460 x 530 mm	1200 mm		–	500 – 1000 mm	0001608000	1,377.- EUR
⑧	R 474 telescopic stand Telescopic stand, H 1200 mm	48 mm	460 x 530 mm	1200 mm		–	500 – 1000 mm	0001643000	1,377.- EUR
⑨	R 472 floor stand Floor stand, H 2020 mm	–	80 x 80 mm	2020 mm		–	980 – 1860 mm	0000738700	3,003.- EUR
⑩	R 4765 floor stand Floor stand, H 1014 – 1588 mm	–	764 x 870 mm	1500 mm		40 kg	465 mm	0030000149	10,352.- EUR
⑪	R 2850 floor stand Floor stand, H 1900 mm	16 mm	980 x 875 mm	1921 mm		8.5 kg	1800 mm	0020002900	2,153.- EUR

* Accessories on page 139

Laboratory Reactors



IKA® lab reactors are the most unique systems when it comes to optimizing and reproducing chemical reaction, mixing, dispersing, and homogenization processes on a lab scale. The lab reactors can be individually customized to perform numerous tasks, including: production of cremes and lotions, the grinding and disintegrating of solids and fibers in liquids or polymers, etc. Single-walled or double-walled vessels made from borosilicate glass or stainless steel are available, each with or without bottom discharge valve.

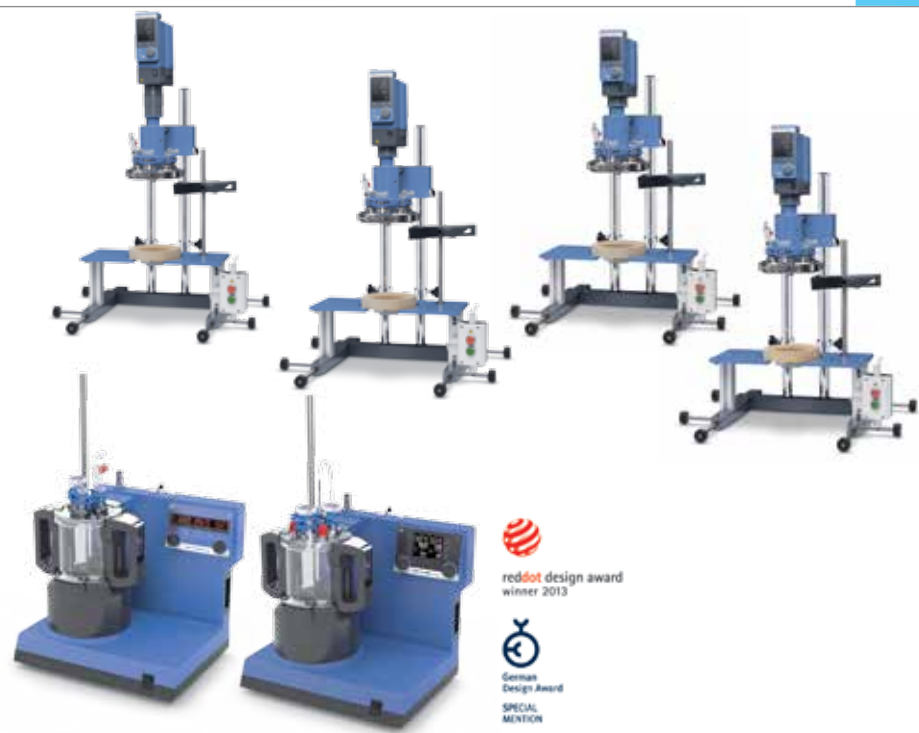

reddot design award
winner 2013

German Design Award
SPECIAL MENTION

The modular, expandable laboratory reactor!

- > Wide range of applications
- > Manual adjustable safety circuit



LR 1000 basic



Digital display for monitoring of speed and temperature



C/T selector button for choosing between the counter or the timer function



Adjustable safety circuit



Connections to attach a cooling source to the back of the unit

Laboratory Reactors

With just one base unit multiple vessels can be used



Technical data	
Usable volume	400 – 1000 ml
Max. working temperature	120 °C
Nominal torque	3 Nm
Attainable vacuum	25 mbar
Max. viscosity	100,000 mPas
Speed range	10 – 150 rpm
Display	LED
Heat output	1000 W
Heat control accuracy	± 1 K
Dimensions (W x D x H)	443 x 295 x 360 mm
Weight	16 kg
Permissible ambient temperature	5 – 40 °C
Permissible relative moisture	80%

LR 1000 basic	LR 1000 control
Usable volume	400 – 1000 ml
Max. working temperature	120 °C
Nominal torque	3 Nm
Attainable vacuum	25 mbar
Max. viscosity	100,000 mPas
Speed range	10 – 150 rpm
Display	TFT
Heat output	1000 W
Heat control accuracy	± 1 K
Dimensions (W x D x H)	443 x 295 x 360 mm
Weight	16 kg
Permissible ambient temperature	5 – 40 °C
Permissible relative moisture	80%

LR 1000 basic Package*	
	Ident. No.
H 11 main cable Euro plug	0001091500
LR 1000 basic base	0003600099
LR 1000.1 reactor vessel	0003602000
LR 1000.61 sensor receptacle	0004664400
PT 100.30 temperature sensor	0004284700
LR 1000 basic Package	0008040100
Price	4,999.- EUR

LR 1000 control Package*	
	Ident. No.
H 11 main cable Euro plug	0001091500
LR 1000 control base	0025001938
LR 1000.3 reactor vessel	0025001955
LR 1000.61 sensor receptacle	0004664400
PT 100.30 temperature sensor	0004284700
USB cable USB A-Micro B 2.0	0004335000
LR 1000 control Package	0010001035
Price	8,903.- EUR

* PT 100.30 included in the delivery for measuring the temperature of the medium



Possibility to connect a pH electrode

LR 1000 control



Integrated weighing function



Large, easy-to-read TFT display for better image quality and easy navigation



Torque trend measurement indicates changes in viscosity of the product



USB interface to control and document rheological changes and other parameters using labworldsoft® software and for updating the firmware



Patented Integrated weighing function



reddot design award winner 2013
German Design Award SPECIAL MENTION

Accessories starting page 149 – 151

Laboratory Reactors | Packages

Modular design laboratory reactor for optimization and simulation of various chemical reactions as well as for mixing and homogenizing processes in a laboratory scale.

- > Suitable for vacuum operation
- > Seals in contact with the product are made of solvent resp. temperature-resistant perfluoroelastomer (FFPM)
- > Infinitely adjustable speed
- > Suited for processing high-viscosity samples at highest temperatures. Various types of agitators can be used with LR-2.ST



Technical data	LR-2.ST
Min. volume (anchor stirrer)	500 ml
Min. volume (T 25 digital)	800 ml
Max. volume	2000 ml
Max. working temperature	230 °C
Attainable vacuum	25 mbar
Max. viscosity (EUROSTAR 200 control P4)	150,000 mPas
Speed range (EUROSTAR 200 control P4)	0/4 – 530 rpm
Max. torque at stirring shaft (EUROSTAR 200 control P4)	660 Ncm
Height of telescopic stand	620 – 1010 mm
Dimensions (W x D x H)	460 x 430 x 1240 mm
Metals in contact with medium	stainless steel (AISI 316L) FFPM borosilicate glass 3.3



LR-2.ST the High-Performer	LR-2.ST the Allrounder	LR-2.ST the Versatile	LR-2.ST the Compact Power
Package consisting of: > LR-2.ST stand system > LR-2.SI safety disconnection > EUROSTAR 200 P4 control overhead stirrer	Package consisting of: > LR-2.ST stand system > LR-2.SI safety disconnection > EUROSTAR 200 control overhead stirrer	Package consisting of: > LR-2.ST stand system > LR-2.SI safety disconnection > EUROSTAR 100 control overhead stirrer	Package consisting of: > LR-2.ST stand system > LR-2.SI safety disconnection > EUROSTAR 60 control overhead stirrer
Price: 9,886.- EUR	Price: 8,997.- EUR	Price: 8,619.- EUR	Price: 8,162.- EUR
Ident. No. 0020013291	Ident. No. 0020013292	Ident. No. 0020013293	Ident. No. 0020013294

Accessories starting page 149 – 151

Laboratory Reactors | Accessories

LR 1000 accessories

	Ident. No.	Price
		
①	LR 1000.1	0003602000 2,613.- EUR
Reactor vessel, 1000 ml, FKM Sealings, 4 connectors, LR 1000.11		
②	LR 1000.3	0025001955 3,252.- EUR
Reactor vessel, 1000 ml, FFKM Sealings, 6 connectors, LR 1000.10		
		
	LR 1000.10	0004663100 327.- EUR
Anchor stirrer with PEEK scrapers		
		
	LR 1000.11	0004663000 193.- EUR
Anchor stirrer, stainless steel		
		
	LR 1000.20	0004663200 255.- EUR
Flow breaker / baffle, stainless steel		

		
	LR 1000.41	0004664300 359.- EUR
Shaft receptacle to install the dispersing elements S 25 KV		
		
	LR 1000.61	0004664400 329.- EUR
Sensor receptacle to install the temperature sensors PT 100.30		
		
	LR 1000.64	0004663300 656.- EUR
pH process electrode		
		
	LR 1000.65	0004663400 555.- EUR
pH electrode receptacle		
		
	WiCO LR 1000	0020007267 446.- EUR
Wireless controller		
		
	LR 1000.70	0025003123 184.- EUR
Lid holder		

LR-2.ST accessories

	Ident. No.	Price
		
	LR 2000.10	0002508400 1,097.- EUR
Anchor stirrer with PTFE scraper		
		
	LR 2000.11	0002509500 511.- EUR
Anchor stirrer, stainless steel		
		
	LR 2000.20	0002508500 501.- EUR
Flow breaker / baffle, stainless steel		
		
	LR-2.SP	0003326400 336.- EUR
Splinter shield		
		
	HBC 5 basic	0004125000 2,750.- EUR
Heating bath circulator		
		
	HBC 5 control	0004127000 3,250.- EUR
Heating bath circulator		

		
	LR 2.1	0003070000 630.- EUR
Reactor vessel, single-walled, 2000 ml		
		
	LR 2000.1	0002508300 2,837.- EUR
Reactor vessel, double-walled, 2000 ml		
		
	LR 2000.2	0002509600 3,562.- EUR
Reactor vessel, double-walled, 2000 ml with bottom drain		
		
	LR 2000.3	0002509700 4,084.- EUR
Stainless steel reactor vessel, double-walled, 2000 ml		
		
	LR 2000.4	0003064900 6,779.- EUR
Stainless steel reactor vessel, double-walled with bottom drain 2000 ml		

Laboratory Reactors | Accessories

LR-2.ST accessories

Ident. No. Price



LR 2000.40 0002509200 445.- EUR

Shaft receptacle to install the dispersing elements S 25 KV



LR 2000.60 0002509300 402.- EUR

Sensor receptacle to install the temperature sensors PT 100.25 and PT 100.5

LR 2000.64 0020010075 931.- EUR

pH process electrode

LR 2000.65 0003172600 657.- EUR

pH measuring sensor receptacle

LT 5.20 0002606700 991.- EUR

Hose, insulated, stainless steel, Ø 10 mm, 1.5 m, 2 pcs.

LT 5.21 0020000988 780.- EUR

Hose, insulated, stainless steel, Ø 13 mm, 1.5 m, 2 pcs.

LT 5.25 0020000878 404.- EUR

Lock coupling

LT 5.26 0020000879 277.- EUR

Lock adapter

LT 5.27 0020000880 404.- EUR

Hose adapter

H 68.55 0025001479 218.- EUR

Temperature sensor, stainless steel, Ø 6 mm

LR-2.ST accessories

Ident. No. Price



HBR 4 - LR control 0010001849 3,311.- EUR

Heating bath, 4 l, incl. PT 1000.61, d: 6 mm, for external temperature regulation of the medium

LR-2.ST and LR 1000 accessories

Ident. No. Price

T 25 - LR digital 0020008820 1,517.- EUR

Disperser

① S 25 KV - 25 F 0002404000 1,661.- EUR

Dispersing element

② S 25 KV - 25 G 0002466900 1,661.- EUR

Dispersing element

③ S 25 KV - 18 G 0002348000 1,619.- EUR

Dispersing element

S 25 KV - 2802 0020008825 1,549.- EUR

Dissolver stirrer, high speed

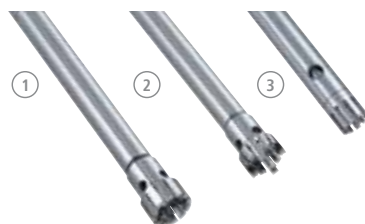

LR-2.ST and LR 1000 accessories

Ident. No. Price



RC 2 basic 0004171000 2,990.- EUR

Recirculating chiller



H.SI.8 0004569000 26.- EUR

Hose, silicone, Ø 8 mm, length 1.5m, 2 pcs.



labworldsoft® 0004720000 1,212.- EUR

Laboratory software

PC 1.1 0002616700 30.- EUR

Cable, length 3 m



PC 4.1 0003192000 1,497.- EUR

RS 232 server

Vacuum pumps

Ident. No. Price



MVP 10 basic 0003980000 1,404.- EUR

Membrane vacuum pump for dry, oil-free applications in the low vacuum range



VCV 1 0020004850 495.- EUR

Vacuum control valve manual



VCV 2 0020004893 821.- EUR

Vacuum control valve digital



VSS 1 0020005194 694.- EUR

Vacuum safety set

magic PLANT



The ideal small laboratory plant for perfect mixing and homogenizing of liquid to pasty products.

Effective dispersing and homogenizing. In connection with the IKA® magicLAB®, the magic PLANT is specially adapted to the requirements of batch plants.

Efficient but gentle mixing and drying of all free flowing solids, including products with different bulk densities and particle sizes.

Technical data	magic PLANT basic	magic PLANT inline	magic PLANT powder
Max. admissible temperature	150 °C	150 °C	150 °C
Working pressure range	-1 up to 2.5 bar	-1 up to 2.5 bar	-1 up to 2.5 bar
Useful volume	2 l	2 l	2 l
Stirring tool	anchor or propeller	propeller	spiral agitator
Speed range	0 – 350 rpm 0 – 2000 rpm	0 – 350 rpm 0 – 2000 rpm	0 – 350 rpm
Price	19,900.- EUR Ident. No. 20001186	28,300.- EUR Ident. No. U107703	20,400.- EUR Ident. No. U107159



The most versatile laboratory reactor

The IKA® magic PLANT is an ideal laboratory scale process plant. This system is used for batch-wise mixing, homogenizing, emulsifying, in addition to forming sample suspensions for capacities of up to 2 liters. Whether it is involved with the manufacturing of liquids, pastes or powders - the magic PLANT delivers, enabling a seamless transition from product development to production.

magic
PLANT



Modular design



Higher viscosity
products processible



Tiltable vessel



Software



IKA®'s software labworldsoft® enables the networking of up to 64 laboratory devices which can be controlled simultaneously via one PC.

Not only IKA® products, but also other manufacturers' laboratory devices can be integrated using labworldsoft®.

CalWin represents the newest generation of professional software for all IKA® calorimeters. It offers numerous functions for monitoring and evaluating results.

Advanced software with an innovative visual approach to lab automation

labworldsoft® is a multi-purpose software program for measuring, controlling and regulating laboratory devices. It can network up to 64 devices simultaneously via one PC, thus making the automation of your laboratory experiments and processes much more easy and efficient. It not only integrates IKA® laboratory devices but also supports devices from other manufacturers.



labworldsoft®

Hardware and software requirements

Pentium processor with at least 16 MB RAM, 8 MB free hard disc memory, VGA-Display: monochrome with at least 16 levels of gray or color, Windows 95/98/2000/NT/ME/XP/7.

Price

1,212.- EUR

Ident. No. 0004720000



C 6040 CalWin

Hardware and software requirements

Windows XP (SP2), Windows Vista, Windows 7, Windows 8 and at least one free USB or RS 232 (9 pin Sub-D (M)) serial interface. Processor with min. 1.6 GHz (single core-Processor); 2 GB RAM; 2.5 GB free hard-disc space; DVD-ROM-drive.

Price

1,946.- EUR

Ident. No. 0004040500*

* Connection cable C 5041.10 and USB / RS 232 adapter are included with the delivery.

IKA® +

Try it for yourself!

Download 30-day trial version at:

www.ika.com

Software | Accessories



Accessories

PCI 8.2 plug-in card

To be integrated into the PC – used for connecting up to 8 devices simultaneously.

Ident. No.	0008017500
Price	1,067.- EUR

PC 4.1 RS 232 server

Can control up to 4 lab units through the ethernet. The server supports 4 RS 232 ports with a 10/100 mbps ethernet interface by TCP/IP. The server can be set-up through the ethernet and works as a transparent serial COM-Port without restrictions of platform and distance.

Ident. No.	0003192000
Price	1,497.- EUR



	Ident. No.	Price
1 Expert Key 100 eco	0020005486	3,123.- EUR
Data collection system for laboratories		
2 Expert Key 100 pro	0020005485	3,300.- EUR
Data collection system for industries		
Multi Power Switch	0020003454	68.- EUR
Adapter for Expert Key		
PT 100.1 A 1	0020004315	55.- EUR
Adapter LEMO for Expert Key		
PT 1000 A 1	0020004316	63.- EUR
Adapter DIN 6 for Expert Key		
PT 100.10 A 1	0020004317	24.- EUR
Adapter DIN 5 for Expert Key		
RV 10 A 1	0020004314	92.- EUR
Adapter valve for Expert Key		
PT100 extension (Lemo)	0020004629	155.- EUR
Extension cable PT 100, LEMO connector, 3 m		
MV 1 power plug	0010001655	422.- EUR
Cooling-water-valve with power plug		

Manufacturers with interface devices compatible to labworldsoft®

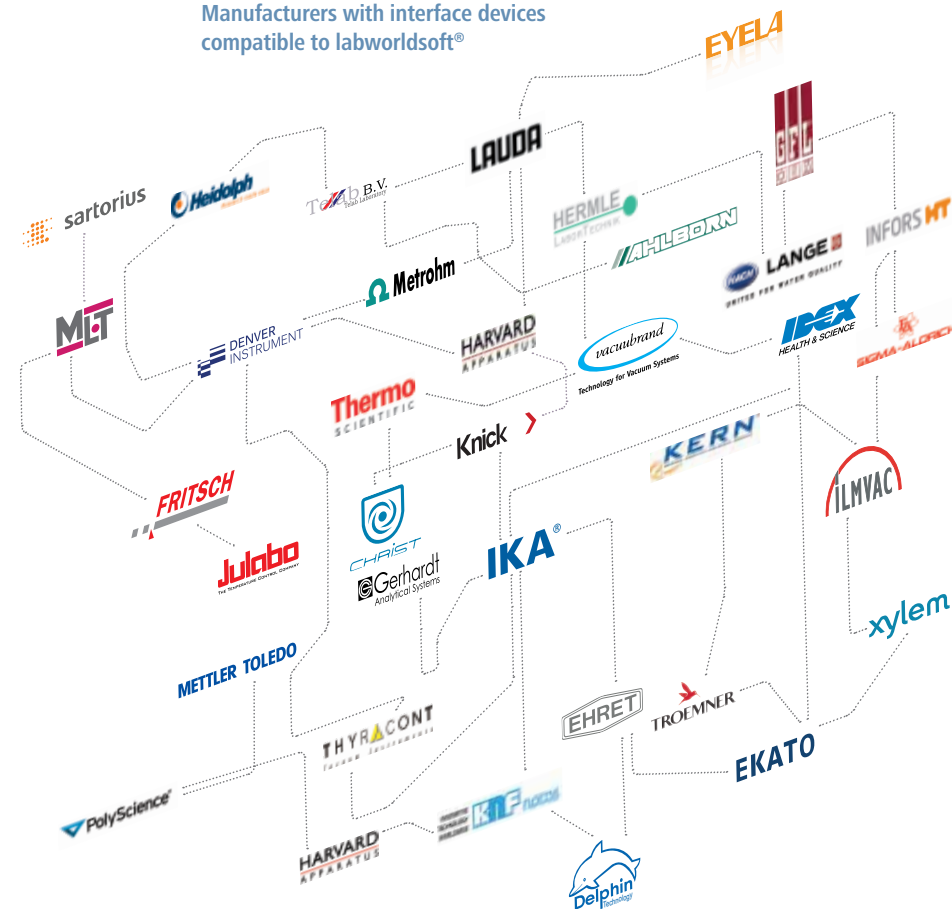

Cable				
	Pins	Length	Ident. No.	Price
PC 1.1 cable	–	3 m	0002616700	30.- EUR
PC 1.5 cable	–	2.5 m	0002756000	28.- EUR
PC 2.1 cable	–	5 m	0002700700	13.- EUR
PC 2.3 cable	–	3 m	0003036200	300.- EUR
DTM 12.10 cable	9 pins (F)	2.5 m	0003127800	270.- EUR
Adapter				
PC 1.2 adapter	25 pins	–	0002616800	48.- EUR
PC 1.4 adapter	9 pins (F), 15 pins (M)	–	0002755900	62.- EUR
PC 2.2 adapter	9 pins (F), 25 pins (M)	–	0002753200	48.- EUR
PC 5.1 adapter	9 pins (F), 15 pins (M)	–	0002621500	125.- EUR

* For more information on cables and adapters, please visit our website: www.ika.com/products

Calorimeters



IKA® oxygen bomb calorimeters are the market leaders when it comes to determining the calorific values of liquid and solid samples. The selection of IKA® oxygen bomb calorimeters are optimally geared towards various different demands. Functionality, safety, and longevity were the main goals in the development of IKA®'s oxygen bomb calorimeters.



The world's smallest calorimeter!

- > Represents the smallest static jacket calorimeter in the world
- > combined modern technology with unique automation

C 1



The traditional heavy screw threaded bomb has been replaced by a light combustion chamber



Automatic oxygen filling, venting and flushing



Automatic ignition with fixed ignition wire as well as ignition energy determination for each experiment



Automatic water filling and draining



Calorimeters



Technical data		C 1	
Maximum energy input		40,000 J	
Resolution of the temperature sensor		0.0001	
Power ON-time		100 %	
Operating oxygen pressure		30 bar	
Measuring modes / Measurements per hour		Static jacket (Regnault Pfaundler)	4
Start temperature settings		2 possible settings: 22 °C or 30 °C	
RSD (using NIST benzoic acid 39j)		Static jacket (Regnault Pfaundler)	0.15 %
Number of decomposition vessel per unit		up to 2	
Price		15,142.- EUR 12,152.- EUR 13,242.- EUR 17,190.- EUR 14,200.- EUR 15,290.- EUR	

C 1 Package 1/10 Ident. No. 0010002412
 C 1 Package 2/10 Ident. No. 0010002413
 C 1 Package 3/10 Ident. No. 0010002414
 C 1 Package 1/12 Ident. No. 0010002415
 C 1 Package 2/12 Ident. No. 0010002416
 C 1 Package 3/12 Ident. No. 0010002417



Software provides control chart view and correction calculation of globally used standards



RFID technology used for decomposition vessel identification



Easy bomb preparation due to new "turned around" crucible holder technology



C 6000 global standards		C 6000 isoperibol	
Maximum energy input		40,000 J	
Resolution of the temperature sensor		0.0001	
Power ON-time		100 %	
Operating oxygen pressure		30 bar	
Measuring modes / Measurements per hour		Adiabatic	5
		Isoperibol (Regnault Pfaundler)	4
		Dynamic	6
Start temperature settings		3 possible settings: 22 °C, 25 °C, 30 °C	
RSD (using NIST benzoic acid 39j)		Adiabatic	0.05 %
		Isoperibol (Regnault Pfaundler)	0.05 %
		Dynamic	0.15 %
Number of decomposition vessel per unit		up to 4	
Price		32,449.- EUR 35,270.- EUR 29,900.- EUR 34,373.- EUR	

Package 1/10 Ident. No. 0010001046
 Package 1/12 Ident. No. 0010001047
 Package 2/10 Ident. No. 0008804300
 Package 2/12 Ident. No. 0008804400

Package 1/10 Ident. No. 0010001048
 Package 1/12 Ident. No. 0010001049
 Package 2/10 Ident. No. 0008804700
 Package 2/12 Ident. No. 0008804800

Accessories starting page 164 – 169

Calorimeters



GOST-certified



Powered with low operating voltage 24 V DC



Automatic precise filling of inner vessel



Short measurement times result in high sample frequency



Precise and reproducible determination of calorific values according to ISO 1928



	C 200	
Technical data		
Maximum energy input	40,000 J	
Resolution of the temperature sensor	0.0001	
Power ON-time	continuous operation	
Operating oxygen pressure	–	
Measuring modes / Measurements per hour	Isoperibol	3
	Dynamic	5
	Manual(Isoperibol)	3
	Time-controlled	4
Start temperature settings	18 – 25 °C	
RSD (using NIST benzoic acid 39j)	Isoperibol	0.1 %
	Dynamic	0.1 %
	Manual (Isoperibol)	0.1 %
	Time-controlled	0.1 %
Number of decomposition vessel per unit	up to 4	

Price 17,305.- EUR | 21,095.- EUR | 19,103.- EUR | 22,484.- EUR

C 200 Ident. No. 0008802500
 C 200 h Ident. No. 0008803700
 C 200 auto Ident. No. 0010002379
 C 200 h auto Ident. No. 0010002387

	C 7000	
Technical data		
Maximum energy input	30,000 J	
Resolution of the temperature sensor	0.0001	
Power ON-time	continuous operation	
Operating oxygen pressure	30 bar	
Measuring modes / Measurements per hour	double dry	
Start temperature settings	12 – 30 °C (cooling water)	
RSD (using NIST benzoic acid 39j)	double dry	0.2 % – 0.5 %
Number of decomposition vessel per unit	up to 4	

Price 37,527.- EUR | 40,218.- EUR

basic set 1 Ident. No. 0008800900
 basic set 2 Ident. No. 0008801400

Calorimeters | Accessories & consumables

C 1 and C 6000 consumables

Ident. No.	Price
------------	-------



C 1.50	0004500600	919.- EUR
--------	------------	-----------

Dot matrix printer

C 1.103	0004579300	34.- EUR
---------	------------	----------

Ignition wire, standard, Kantal, 5 pcs.



C 1.123	0004500200	115.- EUR
---------	------------	-----------

Ignition wire, platinum, 2 pcs.

C 1 accessories and consumables

Ident. No.	Price
------------	-------



C 1.1012	0004500700	144.- EUR
----------	------------	-----------

Organizer



C 1.20	0004501000	1,090.- EUR
--------	------------	-------------

Heater



C 1.30	0004500900	1,624.- EUR
--------	------------	-------------

Venting station



C 1.10	0004500300	352.- EUR
--------	------------	-----------

Combustion chamber



C 1.101	0004502200	270.- EUR
---------	------------	-----------

Set of spare parts, approx. 1000 experiments

C 6000 accessories and consumables

Ident. No.	Price
------------	-------



C 6010	0003770000	2,594.- EUR
--------	------------	-------------

Decomposition vessel, standard



C 6012	0004504000	4,897.- EUR
--------	------------	-------------

Decomposition vessel, halogen resistant



C 6030	0004504100	1,914.- EUR
--------	------------	-------------

Venting station

C 60.1012	0004504200	200.- EUR
-----------	------------	-----------

Organizer

C 6000.10	0004504300	776.- EUR
-----------	------------	-----------

Set of spare parts, approx. 1000 experiments

C 6000.12	0004504400	1,976.- EUR
-----------	------------	-------------

Set of spare parts, approx. 1000 experiments

C 5020	0007145000	5,374.- EUR
--------	------------	-------------

Sample rack

C 200 accessories

Ident. No.	Price
------------	-------

C 248	0003520000	853.- EUR
-------	------------	-----------

Oxygen station

C 200.1	0003548900	36.- EUR
---------	------------	----------

Measuring cup, 2000 ml

C 200.2	0004028800	145.- EUR
---------	------------	-----------

Conversion kit for C 5012



C 5010	0007114000	3,423.- EUR
--------	------------	-------------

Decomposition vessel, standard



C 5012	0007215000	6,953.- EUR
--------	------------	-------------

Decomposition vessel, halogen resistant



C 5030	0007198000	2,305.- EUR
--------	------------	-------------

Venting station



C 5010.4	0003016900	219.- EUR
----------	------------	-----------

Attachment for combustible crucible C 14

C 26	0008804000	173.- EUR
------	------------	-----------

Prep stand

C 1, C 200, C 6000 accessories

Ident. No.	Price
------------	-------

C 25	0003197200	303.- EUR
------	------------	-----------

Pressure regulating valve

C 7000 accessories

Ident. No.	Price
------------	-------

C 7000	0003008000	26,767.- EUR
--------	------------	--------------

Measurement cell

C 7010	0003015000	3,964.- EUR
--------	------------	-------------

Decomposition vessel, standard

C 7012	0003017000	7,719.- EUR
--------	------------	-------------

Decomposition vessel, halogen resistant

C 7002	0007011000	10,239.- EUR
--------	------------	--------------

Cooling system



C 48	0001560000	2,418.- EUR
------	------------	-------------

Oxygen station

C 7030	0003013300	1,829.- EUR
--------	------------	-------------

Venting station

C 7010.8	0007095000	389.- EUR
----------	------------	-----------

Venting handle

C 5010.4	0003016900	219.- EUR
----------	------------	-----------

Attachment for combustible crucible C 14

C 5010.5	0003055900	164.- EUR
----------	------------	-----------

Crucible holder, big

Calorimeters | Accessories & consumables

Accessories for all calorimeters

Ident. No.	Price
------------	-------



C 27	0004579700	95.- EUR
Calorimeter preparation set		



C 29	0000750200	988.- EUR
Pressure gauge, oxygen		



C 21	0001605300	2,838.- EUR
Pelleting press		



C 5010.8	0004579800	135.- EUR
Crucible holder, small		



C 5010.5	0003055900	164.- EUR
Crucible holder, big		

C 200 and C 7000 consumables

Ident. No.	Price
------------	-------



C 5010.3	0007122800	43.- EUR
Ignition wire, spare, 5 pcs.		



C 5012.3	0002994900	119.- EUR
Ignition wire, platinum, 2 pcs.		



C 14	0007224500	69.- EUR
Combustible crucible, 100 pcs.		

Consumables for all calorimeters

Ident. No.	Price
------------	-------



C 1.104	0020003598	11.- EUR
Water bath additive, 30 ml		



C 710.4	0001483700	29.- EUR
Cotton thread, cut to length, 500 pcs.		

C 710.8	0004579900	29.- EUR
Cotton thread, cut to length, thick, 500 pcs.		

C 4	0001695500	23.- EUR
Quartz dish		

C 5	0001749500	113.- EUR
Set of VA combustion crucibles, 25 pcs.		



C 6	0000355100	30.- EUR
Quartz dish, big		



C 710.2	0001483500	172.- EUR
Set of VA combustion crucibles, 25 pcs.		



C 9	0000749900	29.- EUR
Gelatine capsules, 100 pcs.		



C 10	0000750000	79.- EUR
Acetobutyrate capsules, 100 pcs.		



C 12	0002201400	32.- EUR
Combustion bags, 40 x 35 mm, 100 pcs		



C 12 A	0002201500	33.- EUR
Combustion bags, 70 x 40 mm, 100 pcs		



C 15	0003131100	38.- EUR
Paraffin strips, 45 x 3 mm, 600 pcs.		



C 16	0003801100	45.- EUR
Parafilm, 1000 x 50 mm		



C 17	0003801200	73.- EUR
Paraffin, liquid, 30 ml		



C 43	0000750600	495.- EUR
Benzoic acid, NIST 39j, 30 g		



C 723	0003243000	109.- EUR
Benzoic acid, blister package, 0.5 g, 50 pcs.		

C 723 Big Pack	0003717400	681.- EUR
Benzoic acid, blister package, 0.5 g, 450 pcs.		



AOD 1.11	0003044000	240.- EUR
Control standard, 50 ml, for Sulfur and chlorine		



AOD 1.12	0003080200	297.- EUR
Control standard, 50 ml, for fluorine and bromine		

Calorimeters | Accessories & consumables

Calorimeter instructions

Instruction on the IKA® Calorimeter system

on request



Decomposition system

	Ident. No.	Price
AOD 1	0008801300	7,463.- EUR

Decomposition system

AOD 1 consumables

	Ident. No.	Price
--	------------	-------



C 4	0001695500	23.- EUR
-----	------------	----------

Quartz dish



C 9	0000749900	29.- EUR
-----	------------	----------

Gelatine capsules, 100 pcs.



C 10	0000750000	79.- EUR
------	------------	----------

Acetobutyrate capsules, 100 pcs.



C 12	0002201400	32.- EUR
------	------------	----------

Combustion bags, 40x35 mm, 100 pcs.



C 12 A	0002201500	33.- EUR
--------	------------	----------

Combustion bags, 70x40 mm, 100 pcs.



C 14	0007224500	69.- EUR
------	------------	----------

Combustible crucibles, 100 pcs.



C 15	0003131100	38.- EUR
------	------------	----------

Paraffilm strips C 5012.3, Ignition wire, platinum, 2 pcs.



C 5012.3	0002994900	119.- EUR
----------	------------	-----------

Ignition wire, platinum, 2 pcs.



C 710.4	0001483700	29.- EUR
---------	------------	----------

Cotton thread, cut to length, 500 pcs.



AOD 1.11	0003044000	240.- EUR
----------	------------	-----------

Control standard oil for S, CI, 50 ml



AOD 1.12	0003080200	297.- EUR
----------	------------	-----------

Control standard oil for F, Br, 50 ml



C 723	0003243000	109.- EUR
-------	------------	-----------

Benzoic acid, blister package, 50 pcs.



C 723 Big Pack	0003717400	681.- EUR
----------------	------------	-----------

Benzoic acid, blister package, 450 pcs.



Decomposition accessories

	Ident. No.	Price
--	------------	-------



AOD 1.1	0003303000	5,219.- EUR
---------	------------	-------------

Decomposition vessel



AOD 1.2	0003348000	1,226.- EUR
---------	------------	-------------

External ignition unit



AOD 1.3	0003308000	1,999.- EUR
---------	------------	-------------

Protection device

AOD 1.13	0003348100	562.- EUR
----------	------------	-----------

Remote ignition head

C 6040 CalWin

Hardware and software requirements

Windows XP (SP2), Windows Vista, Windows 7, Windows 8 and at least one free USB or RS 232 (9 pin Sub-D (M)) serial interface. Processor with min. 1.6 GHz (single core-Processor); 2 GB RAM; 2.5 GB free hard-disc space; DVD-ROM-drive.

Price	1,946.- EUR
-------	-------------

Ident. No. 0004040500*

* Connection cable C 5041.10 and USB / RS 232 adapter are included with the delivery.

IKA® Packages

Package name / Package description	Ident No.	Price
C-MAG HS 7 Package	0009015900	649.- EUR
C-MAG HS 7	0003581200	
ETS-D5 electronic contact thermometer	0003378000	
H 38 holding rod	0003547700	
H 44 boss head clamp	0002437700	
H 16 V support rod	0001545100	



Package name / Package description	Ident No.	Price
RW 28 digital Package	0009023200	3,278.- EUR
RW 28 digital (drive)	0005040000	
R 2723 telescopic stand	0001412100	
R 1385 propeller stirrer	0000477700	
R 271 boss head clamp	0002664000	
RW 47 digital Package	0009023300	5,608.- EUR
RW 47 digital (drive)	0004050000	
R 2302 propeller stirrer	0000739000	
R 474 telescopic stand	0001643000	



Magnetic stirrers with heating
page 10



Mechanical Overhead stirrers
page 34



Package name / Package description	Ident No.	Price
KS 130 basic Package	0009019000	1,219.- EUR
KS 130 basic	0002980000	
AS 130.3 dish attachment	0003120000	
STICKMAX universal adhesive mat	0003920000	
KS 130 control NOL Package	0009025500	1,407.- EUR
KS 130 control NOL	0004278200	
AS 130.3 dish attachment	0003120000	
STICKMAX universal adhesive mat	0003920000	
KS 260 basic Package	0009019200	1,760.- EUR
KS 260 basic	0002980200	
AS 260.3 dish attachment	0003120600	
2 x STICKMAX universal adhesive mat	0003920000	
KS 260 control NOL Package	0009025600	1,878.- EUR
KS 260 control NOL	0004278400	
AS 260.3 dish attachment	0003120600	
2 x STICKMAX universal adhesive mat	0003920000	

Package name / Package description	Ident No.	Price
T 10 standard PCR kit	0004095500	1,135.- EUR
S 10 D - 7 G - KS - 65 dispersing tool	0020002076	
S 10 D - 7 G - KS - 110 dispersing tool	0020002075	
Disposable generator 7 x 65 mm (12 pcs.)	0003380612	
R 200 clamp	0003372000	
T 18 digital Package	0009022800	1,352.- EUR
T 18 digital	0003720000	
S 18 N - 19 G dispersing tool	000L004640	
T 65 basic Package	0009023400	7,159.- EUR
T 65 basic	0004023500	
S 65 KG - HH - G 65 G dispersing tool	0008005500	
T 653 telescopic stand	0001608000	
T 65 digital Package	0009023500	9,935.- EUR
T 65 digital	0004234500	
S 65 KG - HH - G 65 G dispersing tool	0008005500	
T 653 telescopic stand	0001608000	



T-series ULTRA-TURRAX® Dispersers
page 68



Shakers
page 50



IKA® Packages

①

Package name / Package description	Ident. No.	Price
Open heating bath circulators		
ICC basic eco 8*	0008034900	1,215.- EUR
ICC control eco 8**	0008035300	1,714.- EUR
IB eco 8 bath vessel, plastic	0004248100	
BS.ICC bath bridge	0020003077	
ICC basic eco 18*	0008035000	1,329.- EUR
ICC control eco 18**	0008035400	1,828.- EUR
IB eco 18 bath vessel, plastic	0004248200	
BL.ICC bath bridge	0020003078	
ICC basic pro 9*	0008035100	1,340.- EUR
ICC control pro 9**	0008035500	1,839.- EUR
IB pro 9 bath vessel, stainless steel	0004248500	
BS.ICC bath bridge	0020003077	
ICC basic pro 12*	0010000414	1,402.- EUR
ICC control pro 12**	0010000415	1,890.- EUR
IB pro 12 bath vessel, stainless steel	0004577500	
BL.ICC bath bridge	0020003078	
ICC basic pro 20*	0008035200	1,485.- EUR
ICC control pro 20**	0008035600	1,984.- EUR
IB pro 20 bath vessel, stainless steel	0004248600	
BL.ICC bath bridge	0020003078	

* ICC basic included in delivery
 ** ICC control included in delivery

③

Package name / Package description	Ident. No.	Price
Heating bath circulators with cover		
IC basic pro 12 c*	0008039900	3,044.- EUR
IC control pro 12 c**	0008040000	3,490.- EUR
IB pro 12 bath vessel, stainless steel	0004577500	
CM.IC cover	0004577600	
IC basic pro 20 c*	0008036800	3,168.- EUR
IC control pro 20 c**	0008037200	3,570.- EUR
IB pro 20 bath vessel, stainless steel	0004248600	
CL.IC cover	0004471800	

* IC basic included in delivery
 ** IC control included in delivery. PT 100.30 temperature sensor, CC 1 cooling coil, and BS.IC bridge are all included in the delivery for both IC basic | control packages with cover

②

Package name / Package description	Ident. No.	Price
Heating bath circulators with cover		
ICC basic eco 8 c*	0008035700	1,516.- EUR
ICC control eco 8 c**	0008036100	2,265.- EUR
IB eco 8 bath vessel, plastic	0004248100	
BS.ICC bath bridge	0020003077	
CS.ICC cover	0004471500	
ICC basic eco 18 c*	0008035800	1,662.- EUR
ICC control eco 18 c**	0008036200	2,400.- EUR
IB eco 18 bath vessel, plastic	0004248200	
BL.ICC bath bridge	0020003078	
CL.ICC cover	0004471600	
ICC basic pro 9 c*	0008035900	1,662.- EUR
ICC control pro 9 c**	0008036300	2,410.- EUR
IB pro 9 bath vessel, stainless steel	0004248500	
BS.ICC bath bridge	0020003077	
CS.ICC cover	0004471500	
ICC basic pro 12 c*	0010000416	1,735.- EUR
ICC control pro 12 c**	0010000417	2,483.- EUR
IB pro 12 bath vessel, stainless steel	0004577500	
BL.ICC bath bridge	0020003078	
CM.ICC cover	0025000290	
ICC basic pro 20 c*	0008036000	1,828.- EUR
ICC control pro 20 c**	0008036400	2,576.- EUR
IB pro 20 bath vessel, stainless steel	0004248600	
BL.ICC bath bridge	0020003078	
CL.ICC cover	0004471600	

* ICC basic included in delivery
 ** ICC control included in delivery
 PT 100.30 temperature sensor, CC2 cooling coil, and PCS.ICC pump connection are all included in the delivery for ICC control packages with cover



Temperature Control
page 114

Temperature Control
page 114



IKA® Packages

Package name / Package description	Ident No.	Price
RV 8 V	0010002170	2,349.- EUR
RV 8	0010002484	
HB 10 heating bath	0004068099	
RV 10.1 set of glassware, vertical	0003655300	
RV 10.70 vapor tube, NS 29/32	0003812200	
RV 8 V-C	0010002173	2,481.- EUR
RV 8	0010002484	
HB 10 heating bath	0004068099	
RV 10.10 set of glassware, vertical, coated	0003755400	
RV 10.70 vapor tube, NS 29/32	0003812200	
RV 8 FLEX	0010002166	2,224.- EUR
RV 8	0010002484	
HB 10 heating bath, incl. woulff bottle	0004068099	
RV 05.10 balljoint clamp	0000736600	
RV 10.88 clamp, NS 29	0003683300	
RV 10.70 vapor tube, NS 29/32	0003812200	
RV 10 digital V	0008040300	3,477.- EUR
RV 10 digital	0003550099	
HB 10 heating bath	0004068099	
RV 10.1 set of glassware, vertical	0003655300	
RV 10.70 vapor tube, NS 29/32	0003812200	
RV 10 digital V-C	0008040400	3,767.- EUR
RV 10 digital	0003550099	
HB 10 heating bath	0004068099	
RV 10.10 set of glassware, vertical, coated	0003755400	
RV 10.70 vapor tube, NS 29/32	0003812200	
RV 10 digital FLEX	0008040500	2,606.- EUR
RV 10 digital	0003550099	
HB 10 heating bath, incl. woulff bottle	0004068099	
RV 05.10 balljoint clamp	0000736600	
RV 10.88 clamp, NS 29	0003683300	
RV 10.70 vapor tube, NS 29/32	0003812200	



RV 8



RV 10 digital

Rotary Evaporators
page 128



RV 10 control



RV 10 control auto

Rotary Evaporators
page 130



Package name / Package description	Ident No.	Price
RV 10 control V	0008037700	4,869.- EUR
RV 10 control	0004411099	
HB 10 heating bath	0004068099	
RV 10.1 set of glassware, vertical	0003655300	
RV 10.70 vapor tube, NS 29/32	0003812200	
RV 10.4002 magnetic valve laboratory vacuum	0003880300	
RV 10 control V-C	0008037900	5,174.- EUR
RV 10 control	0004411099	
HB 10 heating bath	0004068099	
RV 10.10 set of glassware, vertical, coated	0003755400	
RV 10.70 vapor tube, NS 29/32	0003812200	
RV 10.4002 magnetic valve laboratory vacuum	0003880300	
RV 10 control FLEX	0008038100	3,955.- EUR
RV 10 control	0004411099	
HB 10 heating bath, incl. woulff bottle	0004068099	
RV 05.10 balljoint clamp	0000736600	
RV 10.88 clamp, NS 29	0003683300	
RV 10.70 vapor tube, NS 29/32	0003812200	
RV 10.4002 magnetic valve laboratory vacuum	0003880300	
RV 10 control V auto	0008037800	7,387.- EUR
RV 10 control	0004411099	
Pump with analog connection	0004406000	
HB 10 heating bath	0004068099	
RV 10.1 set of glassware, vertical	0003655300	
RV 10.70 vapor tube, NS 29/32	0003812200	
RV 10 control V-C auto	0008038000	7,656.- EUR
RV 10 control	0004411099	
Pump with analog connection	0004406000	
HB 10 heating bath	0004068099	
RV 10.10 set of glassware, vertical, coated	0003755400	
RV 10.70 vapor tube, NS 29/32	0003812200	
RV 10 control FLEX auto	0008038200	7,119.- EUR
RV 10 control	0004411099	
Pump with analog connection	0004406000	
HB 10 heating bath, incl. woulff bottle	0004068099	
RV 05.10 balljoint clamp	0000736600	
RV 10.88 clamp, NS 29	0003683300	
RV 10.70 vapor tube, NS 29/32	0003812200	

IKA® Packages

Package name / Package description	Ident. No.	Price
C 1 Package 1/10	0010002412	15,142.- EUR
C 1	0003825000	
RC 2 basic recirculating chiller	0004171000	
C 6000 global standards Package 1/10	0010001046	36,296.- EUR
C 6000 global standards	0003780000	
C 6010 decomposition vessel, standard	0003770000	
RC 2 basic recirculating chiller	0004171000	
C 6000 global standards Package 1/12	0010001047	39,118.- EUR
C 6000 global standards	0003780000	
C 6012 decomposition vessel, halogen resistant	0004504000	
RC 2 basic recirculating chiller	0004171000	
C 6000 global standards Package 2/10	0008804300	35,399.- EUR
C 6000 global standards	0003780000	
C 6010 decomposition vessel, standard	0003770000	
C 6000 global standards Package 2/12	0008804400	38,221.- EUR
C 6000 global standards	0003780000	
C 6012 decomposition vessel, halogen resistant	0004504000	
C 6000 isoperibol Package 1/10	0010001048	32,449.- EUR
C 6000 isoperibol	0004025000	
C 6010 decomposition vessel, standard	0003770000	
RC 2 basic recirculating chiller	0004171000	
C 6000 isoperibol Package 1/12	0010001049	35,270.- EUR
C 6000 isoperibol	0004025000	
C 6012 decomposition vessel, halogen resistant	0004504000	
RC 2 basic recirculating chiller	0004171000	
C 6000 isoperibol Package 2/10	0008804700	31,551.- EUR
C 6000 isoperibol	0004025000	
C 6010 decomposition vessel, standard	0003770000	
C 6000 isoperibol Package 2/12	0008804800	34,373.- EUR
C 6000 isoperibol	0004025000	
C 6012 decomposition vessel, halogen resistant	0004504000	



C 1



C 200



C 6000

Package name / Package description	Ident. No.	Price
C 200 h Package	0008803700	21,095.- EUR
C 200	0003385000	
C 200.2 conversion set for C 5012	0004028800	
C 248 oxygen station	0003520000	
C 5012 decomposition vessel, halogen resistant	0007215000	
C 200 Package	0008802500	17,305.- EUR
C 200	0003385000	
C 5010 decomposition vessel, standard	0007114000	
C 248 oxygen station	0003520000	
C 7000 Set 1	0008800900	37,527.- EUR
C 7000	0003008000	
C 7010 decomposition vessel, standard	0003015000	
C 7002 cooling system	0007011000	
C 48 oxygen station	0001560000	
C 7000 Set 2	0008801400	40,218.- EUR
C 7000	0003008000	
C 7012 decomposition vessel, halogen resistant	0003017000	
cooling system	0007011000	
C 48 oxygen station	0001560000	



C 7000

Calorimeters
page 160



Calorimeters
page 162



IKA® offers more

IKA®
Online

Application
Support

Worldwide
service
network

Customizing
Center

IKA® Online

Get up-to-date information about products, new innovations, videos, photos, press releases and much more

Visit
www.ika.com

Customizing Center

It is important that IKA® products work for your application. We have a special program: product solutions tailored to your needs.

Should you not find the appropriate device in our standard product range, please send us your requested specifications through the online form. Our team will determine its feasibility and offer a solution to you.

Please visit www.ika.com/customizingcenter to review already implemented product modifications.



Worldwide service network – direct contact in your region

Our dedicated team of engineers provides comprehensive worldwide technical service. Please feel free to contact IKA® directly or your dealer in case of any service questions.

For spare parts IKA® guarantees 10 years of availability. In the event of an equipment malfunction or technical questions regarding devices, maintenance and spare parts, please call us at **00 8000 4524357** (00 8000 IKAHELP) or send an email to service@ika.com

IKA® Application Support

Our Application Center spans 400 sqm and offers modern facilities for presenting and testing lab devices and processes. This brings us even closer to our customers and improves our service. Here, prospective buyers and customers can test processes that involve stirring, shaking, dispersing, grinding, heating, analyzing and distilling.

Call us at **00 8000 4522777** (00 8000 IKAAPPS) or send an email to applicationsupport@ika.de or visit our website at www.ika.com/applicationsupport



laboratory equipment
designed for scientists

EN

IKA®-Werke GmbH & Co. KG

Janke & Kunkel-Straße 10, 79219 Staufen, Germany
Telefon: +49 7633 831-0, Fax: +49 7633 831-98
eMail: sales@ika.de

/// WORLDWIDE

USA

IKA® Works, Inc.
Telefon: +1 910 452-7059
eMail: sales@ika.net

MALAYSIA

IKA® Works (Asia) Sdn Bhd
Telefon: +60 3 6099-5666
eMail: sales.lab@ika.my

JAPAN

IKA® Japan K.K.
Telefon: +81 6 6730 6781
eMail: info_japan@ika.ne.jp

CHINA

IKA® Works Guangzhou
Telefon: +86 20 8222 6771
eMail: info@ika.cn

INDIA

IKA® India Private Limited
Telefon: +91 80 2625 3900
eMail: info@ika.in

KOREA

IKA® Korea Ltd.
Telefon: +82 2 2136 6800
eMail: info@ika.kr

BRASIL

IKA® do Brasil
Telefon: +55 19 3772-9600
eMail: info@ika.net.br

POLAND

IKA® Poland Sp. z o.o.
Telefon: +48 22 201 99 79
eMail: sales.poland@ika.com

ENGLAND

IKA® England LTD.
Telefon: +44 1865 986162
eMail: sales.english@ika.com

94000281_201612_POV 2017_A5_Brochure_EN_IWS_EUR

/// ONLINESHOP

Discover and order the fascinating products of IKA online: www.ika.com.

/// SOCIAL MEDIA



IKAworldwide



IKAworldwide /// #lookattheblue



@IKAworldwide

Subject to technical changes and alteration of prices. Prices valid until October 31, 2017.
Prices exclude taxes and other sales related fees.