

# FreeZone® Freeze Dryers & Accessories





## Table of Contents

<b>Why Labconco?</b>	3	<b>Accessories</b>	
<b>Freeze Dryers At-a-Glance</b>		Vacuum Pumps & Accessories	20
Steps to Selecting a Freeze Dryer	4	Tray Drying & Shelf accessories	22
FreeZone® Product Lines	5	Chambers	23
Lyo-Works™ Operating System		Product Shelves & Test Tube Racks	24
Features and Benefits	6	Heated Shelf Chambers	25
<b>FreeZone® Freeze Dryers</b>		Manifolds	26
Benchtop Freeze Dryers Features & Benefits	8	End-Zone™ Starter Kit & Add-On Kit	27
Benchtop Freeze Dryers Ordering Information	9	Stoppering Chambers & Optional Lids	28
Console Freeze Dryers Features & Benefits	10	Secondary Traps	29
Console Freeze Dryers Ordering Information	11	Fast-Freeze™ Flasks	30
Triad™ Freeze Dryers Features & Benefits	12	Fast-Freeze™ Adapters	31
Triad™ Freeze Dryers Ordering Information	13	Fast-Freeze™ Accessories	32
<b>FreeZone® Stoppering Tray Dryers</b>		Serum Bottles & Ampules	33
Features & Benefits	14	FreeZone® Benchtop Shell Freezers	34
Standalone Stoppering Tray Dryers	15	Carts, Shelves & Gauges	35
Consoles w/Stoppering Tray Dryers	16	<b>Specifications</b>	
<b>FreeZone® Bulk Tray Dryers</b>	17	Freeze Dryers	36
<b>FreeZone® Small Tray Dryers</b>	18	Triad™ Freeze Dryers	37
<b>Vacuum Pumps</b>	19	Stoppering Tray Dryers	38
		Bulk & Small Tray Dryers	36

# Built to last.

## The best materials.

Our mission is to build your equipment to the highest possible standards with superior quality materials.

- Environmentally responsible HCFC and CFC-free refrigerants with low GWP
- Durable powder-coated and stainless steel construction
- PTFE-coated collector chambers to resist corrosion
- Wear-resistant, quick-disconnect drain hoses

## The strongest pump protection.

Pump damage can be expensive and slow you down. That's why we make pump protection such a priority.

- Auto shut down if 5 mBar isn't reached during start up
- Patented\* drain line sensor detects moisture before it can damage your pump
- Vacuum break valve prevents oil backstreaming during power outages

## The most flexibility.

- Extend the life of your freeze dryer with endless accessories to help you adapt to the changing needs of your lab. No other manufacturer offers more
- Lyo-Works OS offers truly user-friendly touch screen controls, sample data monitoring and program storage. Stay updated every step of the way, in or out of the lab, with email alerts and our optional End-Zone end point detection

The Labconco logo is a dark blue, horizontally-oriented oval shape. Inside the oval, the word "LABCONCO" is written in a bold, white, sans-serif font. A small registered trademark symbol (®) is located at the end of the word.

# FreeZone® Freeze Dryers

## Steps to Selecting a Freeze Dryer

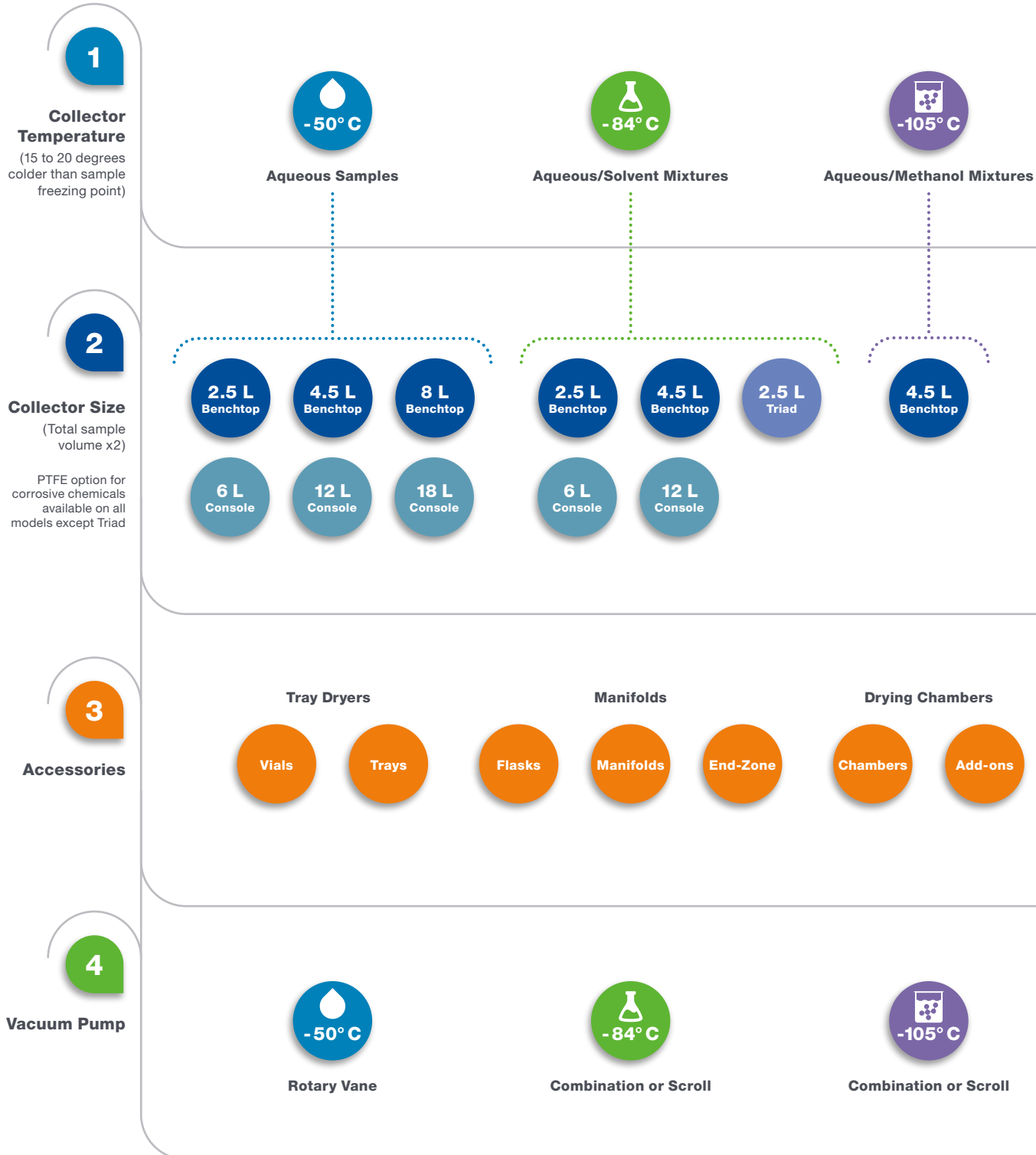

# FreeZone® Freeze Dryers

## FreeZone Product Lines

### Freeze Dryers



2.5 L 4.5 L 8 L

Benchtop



2.5 L

Triad Benchtop



6 L 12 L 18 L

Console and Console with Stoppering Tray Dryer

### Accessories



Tray Dryers



Manifolds



Drying Chambers



Rotary Vane Pump

-50° C



Combination Pump

-84° C -105° C



Scroll Pump

-84° C -105° C

# Labconco for life.

Your research protects and improves how long, and how well, we live. To get there, you need confidence in the viability and stability of your samples.

At Labconco, we leave nothing to chance. You can expect our freeze dryers to deliver the absolute best quality, durability and flexibility available today.

You can also expect us to partner with you for the life of your freeze drying equipment, not just the warranty period. Which can be a long time, because we don't take shortcuts in design or production, and we don't use cut-rate materials.

Everyone talks about having better products and service, but with Labconco, it's actually true.

Labconco, for life.



# Lyo-Works™ Operating System

## Features & Benefits

### Data Logging

Starts/stops logging. View the data in table or graph form.

### Settings

Select language, security code, sensor calibration, time/date/time zone, alert emails and other settings.

### Sensors

Displays temperature values for sensors.

### Tray Dryers

Allows you to program or manually control shelf temperatures of installed tray dryers with temperature control.

### Programs

Lets you create, edit, view and initiate programs. Stores up to 30 programs with up to 16 steps each.

### End Point Detection

When End-Zone is installed, indicates when end point is reached for each sensor.

### Home Screen

Get at-a-glance collector temperature, vacuum pressure, and, if equipped, built-in shell freezer temperature.

### Help

Access diagnostic tools, user manuals, videos, and updates

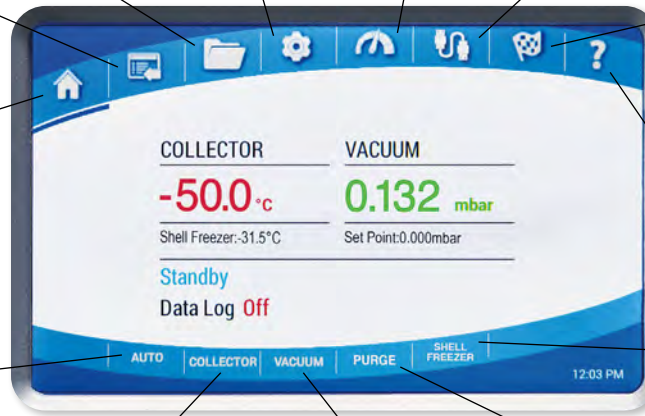

### Auto

Initiates the start up sequence: collector cool down, vacuum pull down and optional purge valve. Ensures collector reaches -40° C before vacuum is applied.

### Shell Freezer

Controls optional built-in shell freezer.

### Collector

Manually starts/stops the collector and starts/stops defrost.

### Vacuum

Manually starts/stops the vacuum pump.

### Purge

Controls the optional purge valve.

**Lyo-Works** is more than a large touch screen display. It's a set of powerful controls and useful insights about your freeze drying process. Lyo-Works gives you greater peace of mind about the integrity of your samples throughout lyophilization, even when you're not in the lab.



### USB port and Ethernet connection

Lets you easily output Lyo-Works data in CSV format to a flash drive or via email.

See how Lyo-Works works at [labconco.com/lyo-works](http://labconco.com/lyo-works).

# FreeZone® Benchtop Freeze Dryers

## Features & Benefits



**Vacuum break valve** prevents oil backstreaming when power to the freeze dryer or pump is shut off.

**Patented\* moisture sensor** protects the vacuum pump by preventing refrigeration or vacuum start-up when moisture is detected in collector chamber area.

**Durable steel cabinet** Benchtop models fit countertops and lab carts.

**USB port and Ethernet** to download onboard data.

**Upright, stainless steel collector chamber** speeds and simplifies defrost. Available with PTFE-coated collector coil and chamber for additional corrosion resistance.

**Quick disconnect drain hose fitting** for convenient defrost.

**Vacuum control valve** maintains set point vacuum level to speed the freeze drying process.

**Hot gas defrost** automatically shuts off when defrosting is complete.

**Full one year warranty**

\*U.S. Patent No. 6,968,631





# FreeZone® Benchtop Freeze Dryers

## Ordering Information



**2.5 Liter**

Light sample loads



**4.5 Liter**

Light to moderate sample loads



**8 Liter**

Moderate sample loads

**Catalog Number Configurator** Use this key to configure the nine digit catalog number.

7    0  0

Select the **REFRIGERATION TEMPERATURE** of your freeze dryer's collector. This is the second digit.

- 0** = -50° C (-58° F). For samples containing water.
- 1** = -84° C (-119° F). For low eutectic point samples containing water or acetonitrile.
- 2** = -105° C (-157° F) at 60 Hz or -102° C (-152° F) at 50 Hz. For low eutectic point samples containing water, acetonitrile or dilute methanol or ethanol. (4.5 L only)

Select the **CAPACITY** of your freeze dryer's collector. These are the third and fourth digits.

- 02** = 2.5 L      **04** = 4.5 L      **08** = 8 L (-50° C only)

Select the **COLLECTOR COIL** and **CHAMBER MATERIAL** of your freeze dryer. This is the sixth digit.

- 1** = Stainless steel      **2** = PTFE-coated stainless steel

Select the **ELECTRICAL CONFIGURATION** and **OUTLET TYPE** of your freeze dryer. These are the eighth and ninth digits.

- 00** = 115V, 60 Hz, with 20A plug for North America
- 10** = 230V, 60 Hz, with plug for North America
- 15** = 230V, 60 Hz, with plug for Saudi Arabia
- 30** = 230V, 50 Hz, with Schuko plug
- 40** = 230V, 50 Hz, with plug for China/Australia
- 50** = 230V, 50 Hz, with plug for Great Britain (UK)
- 70** = 230V, 50 Hz, with plug for India
- 90** = 230V, 50 Hz, with Schuko, China/Australia, Great Britain (UK) and India

### All models require (not included):

- Vacuum pump with a displacement of at least 98 L/min, 0.02 mBar ultimate pressure and fitting for 3/4" ID vacuum hose. See pages 19-20
- Drying accessory. See pages 18, 22, 24-25
- Freeze dry glassware if not bulk freeze drying. See pages 29-32

### Electrical Requirements, Dimensions & Shipping Weights

Collector Capacity	Water removed in 24 hrs	Refrigeration Temperature	Volts	Amps	Overall Dimensions (w x d x h)	Shipping Weight
<b>2.5 L*</b>	2 L	-50° C (-58° F)	115	14**	14.5" x 19.2" x 16.9"	120 lbs. (54 kg)
<b>2.5 L</b>	2 L	-50° C (-58° F)	230	7†	14.5" x 19.2" x 16.9"	120 lbs. (54 kg)
<b>2.5 L*</b>	2.2 L	-84° C (-119° F)	115	16**	14.5" x 24.5" x 16.9"	165 lbs. (75 kg)
<b>2.5 L</b>	2.2 L	-84° C (-119° F)	230	10†	14.5" x 24.5" x 16.9"	165 lbs. (75 kg)
<b>4.5 L*</b>	2 L	-50° C (-58° F)	115	14**	16.5" x 22.4" x 18.9"	139 lbs. (63 kg)
<b>4.5 L</b>	2 L	-50° C (-58° F)	230	7†	16.5" x 22.4" x 18.9"	139 lbs. (63 kg)
<b>4.5 L*</b>	4 L	-84° C (-119° F)	115	16**	22.5" x 26.5" x 18.5"	197 lbs. (89 kg)
<b>4.5 L</b>	4 L	-84° C (-119° F)	230	10†	22.5" x 26.5" x 18.5"	197 lbs. (89 kg)
<b>4.5 L*</b>	2.5 L	-105° C (-15° F)	115	16**	22.5" x 26.5" x 18.5"	205 lbs. (93 kg)
<b>4.5 L</b>	2.5 L	-105° C (-15° F)	230	10†	22.5" x 26.5" x 18.5"	205 lbs. (93 kg)
<b>8 L*</b>	4 L	-50° C (-58° F)	115	14*	22.5" x 26.5" x 18.5"	173 lbs. (79 kg)
<b>8 L</b>	4 L	-50° C (-58° F)	230	7**	22.5" x 26.5" x 18.5"	173 lbs. (79 kg)

\*Requires 20 amp dedicated circuit.

\*\*System amperage shown includes 8 amp maximum vacuum pump rating. †System amperage shown includes 4.5 amp maximum vacuum pump rating.

# FreeZone® Console Freeze Dryers

## Features & Benefits



### Optional built-in shell freezer

with stainless steel bath and separate refrigeration system holds flasks up to 1200 mL. 6L only.

### Optional built-in mini vacuum drying chamber

holds small samples, either in bulk or in small containers such as serum bottles.

### Vacuum break valve

prevents oil backstreaming when power to the freeze dryer or pump is shut off.

### Durable steel cabinet

has casters for mobility and a two-piece brushed stainless steel front panel. Left side panel is easy to remove for access to the vacuum pump (pump sold separately). A window lets you see pump oil status.

### Patented\* moisture sensor

protects the vacuum pump by preventing refrigeration or vacuum start-up when moisture is detected in collector chamber area.

### Upright, stainless steel collector chamber

speeds and simplifies defrost. Available with PTFE-coated collector coil and chamber for additional corrosion resistance.

### Quick-disconnect drain hose fitting

for convenient defrost.

### Vacuum control valve

maintains set point vacuum level to speed the freeze drying process.

### Hot gas defrost

automatically shuts off when defrosting is complete.

### USB port and Ethernet

to download onboard data.

### Optional purge valve

isolates vacuum pump from the freeze dryer. The pump starts and warms the oil while the collector cools, before pulling vacuum. Can be used after run to purge contaminants from oil to extend pump life.

### Full one year warranty

\*U.S. Patent No. 6,968,631



# FreeZone® Console Freeze Dryers

## Ordering Information



6 Liter



12 Liter



18 Liter

- Moderate to large sample loads or numerous sample batches
- Compatible with the FreeZone Stopping Tray Dryer or Bulk Tray Dryer (tray dryer sold separately)

**Catalog Number Configurator** Use this key to configure the nine digit catalog number.

7    1

Select the **REFRIGERATION TEMPERATURE** of your freeze dryer's collector. This is the second digit.

- 0** = -50° C (-58° F). For samples containing water.
- 1** = -84° C (-119° F). For low eutectic point samples containing water or acetonitrile. (6 L and 12 L only)

Select the **CAPACITY** of your freeze dryer's collector. These are the third and fourth digits.

- 06** = 6 L      **12** = 12 L      **18** = 18 L (-50° C only)

Select the **COLLECTOR COIL** and **CHAMBER MATERIAL** of your freeze dryer. This is the sixth digit.

- 1** = Stainless steel      **2** = PTFE-coated stainless steel

Select the **BUILT-IN OPTION**. This is the seventh digit.

- 0** = None
- 1** = Purge Valve
- 2** = Purge Valve and Mini Chamber. Add 20 lbs. (9 kg) to shipping weight.
- 3** = Purge Valve and Shell Freezer. (6 L -50° C only). Add 80 lbs. (36 kg) to shipping weight.

Select the **ELECTRICAL CONFIGURATION** and **OUTLET TYPE** of your freeze dryer. These are the eighth and ninth digits.

- 00** = 115V, 60 Hz, with 20A plug for North America (6 L only)
- 10** = 230V, 60 Hz, with plug for North America
- 15** = 230V, 60 Hz, with plug for Saudi Arabia
- 30** = 230V, 50 Hz, with Schuko plug
- 40** = 230V, 50 Hz, with plug for China/Australia
- 50** = 230V, 50 Hz, with plug for Great Britain (UK)
- 70** = 230V, 50 Hz, with plug for India
- 90** = 230V, 50 Hz, with Schuko, China/Australia, Great Britain (UK) and India

### All models require (not included):

- Vacuum pump with a displacement of at least 98 L/min, 0.02 mBar ultimate pressure and fitting for 3/4" ID vacuum hose. See pages 19-20
- Drying accessory. See pages 14-15, 17-18, 22, 24-25
- Freeze dry glassware if not bulk freeze drying. See pages 29-32

### Electrical Requirements, Dimensions & Shipping Weights

Collector Capacity	Water removed in 24 hrs	Refrigeration Temperature	Volts	Amps	Overall Dimensions (w x d x h)	Shipping Weight
6 L*	4 L	-50° C (-58° F)	115	16**	31.8" x 29.6" x 36.6"	285 lbs. (129 kg)
6 L	4 L	-50° C (-58° F)	230	8†	31.8" x 29.6" x 36.6"	285 lbs. (129 kg)
6 L*	4 L	-84° C (-119° F)	115	16**	31.8" x 29.6" x 36.6"	299 lbs. (136 kg)
6 L	4 L	-84° C (-119° F)	230	10**	31.8" x 29.6" x 36.6"	299 lbs. (136 kg)
12 L	8 L	-50° C (-58° F)	230	9†	31.8" x 29.6" x 36.6"	310 lbs. (141 kg)
12 L	6.5 L	-84° C (-119° F)	230	9†	31.8" x 29.6" x 36.6"	350 lbs. (159 kg)
18 L	10 L	-50° C (-58° F)	230	9*	31.8" x 29.6" x 36.6"	315 lbs. (143 kg)

\*Requires 20 amp dedicated circuit.

\*\*System amperage shown includes 8 amp maximum vacuum pump rating. †System amperage shown includes 4.5 amp maximum vacuum pump rating.

# FreeZone® Triad® Freeze Dryers

## Features & Benefits



### Heated and cooled shelf

Separate HCFC/CFC-free refrigeration system and 1000 watt heater

### Four valve ports

Versatile Triad lets you freeze dry samples in flasks and on the shelf at the same time.

**USB port and Ethernet** to download onboard data.

### Pneumatic mechanism stoppers containers on shelf

Containers are stoppered while chamber is under vacuum and without the use of compressed gas. Atmospheric pressure causes the diaphragm to expand.

### Pre-freeze samples

on the shelves at a controlled rate (annealing). Improves sample quality and eliminates need for a separate freezer and product transfer.

### Large processing shelf

12.4" w x 14.5" d.

Accommodates containers with stoppers up to 148 mm maximum height.

### Collector drain pan and hose

Removeable stainless steel drain pan catches defrosted condensate.

**Full one year warranty**

## Serum Bottle Capacity

Size	Catalog Number	Shelf Capacity
2 ml	7575010	400
3 ml	7575210	441
5 ml	7573010	233
10 ml	7573210	196
20 ml	7573410	121
30 ml	7573610	86
50 ml	7573810	64
100 ml	7574010	42
125 ml	7574210	36



# FreeZone® Triad® Freeze Dryers

## Ordering Information



2.5 Liter Triad

- Small sample loads or numerous sample batches containing water or acetonitrile
- Stopping vials or serum bottles under vacuum
- Limited floor space

**Catalog Number Configurator** Use this key to configure the nine digit catalog number.

7 9 4 0 0 1 0

Select the **ELECTRICAL CONFIGURATION** and **OUTLET TYPE** of your freeze dryer. These are the eighth and ninth digits.

10 =  230V, 60 Hz, with plug for North America

15 =  230V, 60 Hz, with plug for Saudi Arabia

30 =  230V, 50 Hz, with Schuko plug

40 =  230V, 50 Hz, with plug for China/Australia

50 =  230V, 50 Hz, with plug for Great Britain (UK)

70 =  230V, 50 Hz, with plug for India

90 =  230V, 50 Hz, with Schuko, China/Australia, Great Britain (UK) and India

### All models require (not included):

- Vacuum pump with a displacement of at least 98 L/min, 0.02 mBar ultimate pressure and fitting for 3/4" ID vacuum hose. See pages 19-20
- Freeze dry glassware if not bulk freeze drying. See pages 29-32.
- Optional trays available. see page 21

### Dimensions & Shipping Weights

Collector Capacity	Refrigeration Temperature	Overall Dimensions (w x d x h)	Shipping Weight
2.5 L	-84° C (-119° F) Volts (230), Amps (12)	28.3" x 29.5" x 27.7"	440 lbs. (200 kg)

# FreeZone® Stoppering Tray Dryers

## Features & Benefits

### Heated and cooled shelves

Separate HCFC/CFC-free refrigeration system and 1000 watt heater.

### Vacuum release valve control

vents the chamber allowing the door to be opened.

**Stoppering knob** controls shelf stoppering mechanism.

**Three RTD sensor probes** monitor sample temperature.

### 1/8" OD backfill port

introduces inert gas from an outside source to the chamber, protecting samples from atmospheric moisture and contaminants.

### Pre-freeze samples

on the shelves at a controlled rate (annealing). Improves sample quality and eliminates need for a separate freezer and product transfer.

### Three large adjustable shelves

accommodate bulk trays or batches of serum bottles or ampules. Samples may be lyophilized and then stoppered on the shelves.



Shown with optional built-in 6-Port Tray Dryer Manifold

### Optional built-in 6-Port Tray Dryer Manifold

increases flexibility and capacity. Samples may be simultaneously freeze dried in flasks or other glassware. Also available as a field-installable accessory. See page 21 for ordering information.

### Optional built-in isolation valve

separates Stoppering Tray Dryer from Freeze Dryer to shorten time necessary to reestablish working vacuum levels and to provide a means for checking end point. Also available as a field-installable accessory. See page 21 for ordering information.

**Compatible with 6, 12, and 18L Console with Lyoworks OS.**

Size	Catalog Number	Shelf Capacity	Number of Shelves	Total Capacity
2 ml	7575010	430	3	1290
3 ml	7575210	483	3	1449
5 ml	7573010	228	3	684
10 ml	7573210	195	3	585
20 ml	7573410	132	3	396
30 ml	7573610	86	3	258
50 ml	7573810	72	2	144
100 ml	7574010	42	2	84
125 ml	7574210	36	1	36

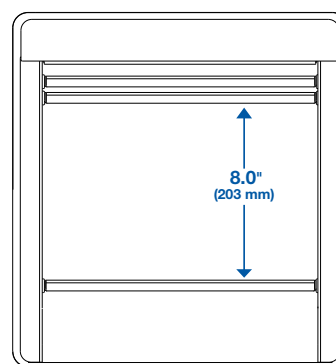
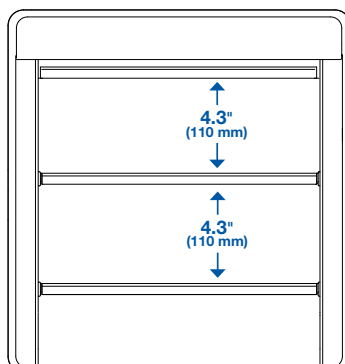
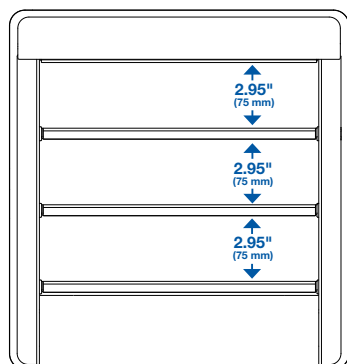

Stoppering Tray Dryer Shelf Spacing Dimensions.  
Note: Adjustable shelves allow for additional spacing options.



# FreeZone® Stoppering Tray Dryers

## Ordering Information



Shown with optional built-in 6-Port Tray Dryer Manifold

**Catalog Number Configurator** Use this key to configure the nine digit catalog number. To order your FreeZone Stoppering Tray Dryer and Freeze Dryer together as one catalog number, see page 16.

7 9 4 8 0 1

Select **BUILT-IN OPTIONS**. This is the seventh digit.

- 0 = None
- 1 = 6-Port Tray Dryer Manifold
- 2 = Isolation Valve
- 3 = 6-Port Tray Dryer Manifold and Isolation Valve

Select the **ELECTRICAL CONFIGURATION** and **OUTLET TYPE** of your freeze dryer. These are the eighth and ninth digits.

- 00 = 115V, 60 Hz, with 20A plug for North America
- 10 = 230V, 60 Hz, with plug for North America
- 15 = 230V, 60 Hz, with plug for Saudi Arabia
- 30 = 230V, 50 Hz, with Schuko plug
- 40 = 230V, 50 Hz, with plug for China/Australia
- 50 = 230V, 50 Hz, with plug for Great Britain (UK)
- 70 = 230V, 50 Hz, with plug for India
- 90 = 230V, 50 Hz, with Schuko, China/Australia, Great Britain (UK) and India

### All models require (not included):

- FreeZone 6, 12 or 18 Liter Console Freeze Dryer with Lyo-Works OS. FreeZone Stoppering Tray Dryer and Freeze Dryer may be ordered as separate components or together as one catalog number on selected models of FreeZone 6, 12 or 18 Liter Console Freeze Dryers See page 16
- Vacuum pump with a displacement of at least 163 L/min, 0.02 mBar ultimate pressure and fitting for 3/4" ID vacuum hose. See pages 19-20
- Freeze dry glassware if not bulk freeze drying. See pages 29-32

### Electrical Requirements

Volts	Amps
115	16
230	9

### Shipping Weights

Built-In Options Included	Shipping Weight
None	423 lbs. (192 kg)
6-Port Tray Dryer Manifold	438 lbs. (199 kg)
Isolation Valve	431 lbs. (196 kg)
6-Port Tray Dryer Manifold and Isolation Valve	458 lbs. (208 kg)

# FreeZone® Console Freeze Dryers with Stoppering Tray Dryer

## Ordering Information



6 Liter



12 Liter



18 Liter

- Moderate to large sample loads or numerous sample batches
- Stoppering vials or serum bottles under vacuum

**Catalog Number Configurator** Use this key to configure the nine digit catalog number.

7    2

Select the **REFRIGERATION TEMPERATURE** of your freeze dryer's collector. This is the second digit.

- 0** = -50° C (-58° F). For samples containing water.
- 1** = -84° C (-119° F). For low eutectic point samples containing water or acetonitrile. (6 L and 12 L only)

Select the **CAPACITY** of your freeze dryer's collector. These are the third and fourth digits.

- 06** = 6 L      **12** = 12 L      **18** = 18 L (-50° C only)

Select the **COLLECTOR COIL** and **CHAMBER MATERIAL** of your freeze dryer. This is the sixth digit.

- 1** = Stainless steel      **2** = PTFE-coated stainless steel

Select the **BUILT-IN OPTION**. This is the seventh digit.

- 0** = None      **1** = Purge Valve

Select the **ELECTRICAL CONFIGURATION** and **OUTLET TYPE** of your freeze dryer. These are the eighth and ninth digits.

- 00** = 115V, 60 Hz, with 20A plug for North America (6 L)
- 10** = 230V, 60 Hz, with plug for North America
- 15** = 230V, 60 Hz, with plug for Saudi Arabia
- 30** = 230V, 50 Hz, with Schuko plug
- 40** = 230V, 50 Hz, with plug for China/Australia
- 50** = 230V, 50 Hz, with plug for Great Britain (UK)
- 70** = 230V, 50 Hz, with plug for India
- 90** = 230V, 50 Hz, with Schuko, China/Australia, Great Britain (UK) and India

### All models require (not included):

- Vacuum pump with a displacement of at least 163 L/min, 0.02 mBar ultimate pressure and fitting for 3/4" ID vacuum hose. See pages 19-20
- Freeze dry glassware if not bulk freeze drying. See pages 29-32

### Electrical Requirements, Dimensions (Tray Dryer mounted on Console) & Shipping Weights (Two Cartons)

Collector Capacity	Water removed in 24 hrs	Refrigeration Temperature	Volts	Console Amps	Tray Dryer Amps	Overall Dimensions (w x d x h)	Shipping Weight
6 L*	4 L	-50° C	115	16**	16	32.4" x 29.6" x 63.7"	678 lbs. (308 kg)
6 L	4 L	-50° C	230	8†	9	32.4" x 29.6" x 63.7"	678 lbs. (308 kg)
6 L*	4 L	-84° C	115	16**	16	32.4" x 29.6" x 63.7"	693 lbs. (314 kg)
6 L	4 L	-84° C	230	10**	9	32.4" x 29.6" x 63.7"	693 lbs. (314 kg)
12 L	8 L	-50° C	230	9†	9	32.4" x 29.6" x 63.7"	698 lbs. (317 kg)
12 L	6.5 L	-84° C	230	9†	9	32.4" x 29.6" x 63.7"	743 lbs. (337 kg)
18 L	10 L	-50° C	230	9†	9	32.4" x 29.6" x 63.7"	713 lbs. (323 kg)

\*Requires 20 amp dedicated circuit.

\*\*System amperage shown includes 8 amp maximum vacuum pump rating. †System amperage shown includes 4.5 amp maximum vacuum pump rating.



# FreeZone® Bulk Tray Dryers

## Ordering Information



### 3 Heated Shelves with Sensors

Each stainless steel shelf includes a 200-watt heater and a sample temperature probe.

### Bulk Tray Dryers with heated shelves

Moderate to large bulk sample loads or numerous sample batches

### Bulk Tray Dryer models require (not included):

- FreeZone 6, 12 or 18 Liter Console Freeze Dryer with Lyo-Works OS. See pages 10-11
- Vacuum pump with a displacement of at least 163 L/min, 0.02 mBar ultimate pressure and fitting for 3/4" ID vacuum hose. See pages 19-20
- Freeze dry glassware if not bulk freeze drying. See pages 29-32
- 115V models require 8A; 230V models require 4A

**Catalog Number Configurator** Use this key to configure the nine digit catalog number.

7 8 0 6 0 1      

Select **BUILT-IN OPTIONS**. This is the seventh digit.

- 0 = None      1 = 6-Port Tray Dryer Manifold  
 2 = Isolation Valve      3 = 6-Port Tray Dryer Manifold & Isolation Valve

Select the **ELECTRICAL CONFIGURATION** and **OUTLET TYPE**. These are the eighth and ninth digits.

- 00 = 115V, 60 Hz, with 20A plug for North America  
 10 = 230V, 60 Hz, with plug for North America  
 15 = 230V, 60 Hz, with plug for Saudi Arabia  
 30 = 230V, 50 Hz, with Schuko plug  
 40 = 230V, 50 Hz, with plug for China/Australia  
 50 = 230V, 50 Hz, with plug for Great Britain (UK)  
 70 = 230V, 50 Hz, with plug for India  
 90 = 230V, 50 Hz, with Schuko, China/Australia, Great Britain (UK) and India

### Shipping Weights

Options Included	Shipping Weight
None	248 lbs. (113 kg)
6-Port Tray Dryer Manifold	263 lbs. (119 kg)
Isolation Valve	256 lbs. (116 kg)
6-Port Tray Dryer Manifold and Isolation Valve	283 lbs. (128 kg)

### Optional Heated Shelves with Sensors 12.7" w x 16.6" d.

FreeZone Bulk Tray Dryers include three and can accommodate two additional Heated Shelves with Sensors.

Catalog Number	Description	Shipping Weight
730151020	Shelf for 115V, 50/60 Hz operation	6.0 lbs. (2.7 kg)
730151030	Shelf for 230V, 50/60 Hz operation	6.0 lbs. (2.7 kg)

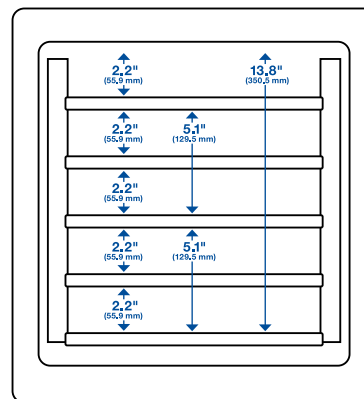

Bulk Tray Dryer Shelf Spacing Dimensions



# FreeZone® Small Tray Dryers

## Ordering Information



### Small Tray Dryers with heated shelves

Small to moderate bulk sample loads

### Heated Small Shelves with Sensors

Includes 3 Heated Shelves with option for 2 additional heated shelves. Each stainless steel shelf includes a 200-watt heater and a sample temperature probe

**Optional Heated Small Shelves with Sensors** 10.6" w x 12.0" d. FreeZone Small Tray Dryers include three and can accommodate two additional Heated Shelves with Sensors.

Catalog Number	Description	Shipping Weight
730152020	Shelf for 115V, 50/60 Hz operation	15 lbs. (7 kg)
730152030	Shelf for 230V, 50/60 Hz operation	15 lbs. (7 kg)
736581000	Temperature Probe only (For Bulk and Small Tray Dryer Heated Shelves)	0.5 lb. (0.2 kg)

Catalog Number	Electrical Requirement	Receptacle & Plug Type
780701000	115V, 60 Hz, 5A	115V, 60 Hz for North America
780701010	230V, 60 Hz, 2.5A	230V, 60 Hz for North America
780701015	230V, 60 Hz, 2.5A	230V, 60 Hz for Saudi Arabia
780701030	230V, 50 Hz, 2.5A	230V, 50 Hz Schuko
780701040	230V, 50 Hz, 2.5A	230V, 50 Hz for China/Australia
780701050	230V, 50 Hz, 2.5A	230V, 50 Hz for Great Britain (UK)
780701070	230V, 50 Hz, 2.5A	230V, 50 Hz for India
780701090	230V, 50 Hz, 2.5A	230V, 50 Hz for Schuko, China/Australia, Great Britain (UK), and India

### Small Tray Dryer models require (not included):

- Any FreeZone Freeze Dryer with Lyo-Works OS
- Vacuum pump with a displacement of at least 98 L/min, 0.020 mBar ultimate pressure and fitting for 3/4" ID vacuum hose. See pages 19-20
- Freeze dry glassware if not bulk freeze drying. See pages 29-32

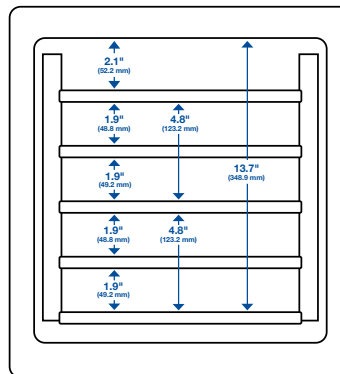

**7522700—Dry Ice Benchtop Freeze Dryer.** For occasional lyophilization requirements. Chamber, 8.8" dia. x 9.8" h type 304 stainless steel with 12 valves and capacity of 1 liter of ice. Valves accommodate either 1/2" or 3/4" flask adapters. Includes dry ice/solvent center well with 1.92 liter capacity and cover, 1/2" OD port for connection to vacuum pump and 3/8" OD port for connection to vacuum gauge. **Dry ice, heat transfer solution, vacuum pump, vacuum gauge, tubing and glassware are required (not included).** See pages 19-20 for vacuum pumps and accessories. See pages 29-32 for glassware. Shipping weight 11 lbs. (5 kg)



# Vacuum Pumps

## Features & Benefits



### General Purpose Rotary Vane Vacuum Pumps

- Designed for use with aqueous samples
- Single phase direct drive motor, totally enclosed and fan cooled. Should the motor overheat, the thermal overload device switches off the pump. When the pump cools down, the motor automatically restarts
- Ultimate vacuum  $2 \times 10^{-3}$  mBar (1.5 micron)







### VACUUBRAND HYBRID\* Vacuum Pumps

- Designed for use with acids and other harsh chemicals including TFA, TFA by-products, acetonitrile, HBe and  $\text{HNO}_3$  present in samples such as HPLC-prepared and peptide purified materials
- Comprised of a two-stage rotary vane pump and two-stage, chemical-resistant diaphragm pump. Provide deep vacuum required for good freeze drying and evaporation and have superior solvent and acid handling capabilities
- Ultimate vacuum  $2 \times 10^{-3}$  mBar (1.5 micron)



### Scroll Vacuum Pumps

- Designed for use with acids below 20% concentration and solvents including acetonitrile
- Two spiral scrolls compress air and vapors to move them toward the exhaust
- Oil-free design has no hydrocarbons
- Ultimate vacuum  $7 \times 10^{-3}$  mBar (5.3 micron) for 7587000
- Ultimate vacuum (partial pressure)  $2 \times 10^{-2}$  mBar (15 micron) for 7587100

FreeZone Model	Sample Contains	Pump Type	Recommended Pump ( $\geq 98$ lpm)**		Recommended Pump ( $\geq 163$ lpm)	
			115 Volts	230 Volts	115 Volts	230 Volts
 <b>Benchtop 2.5, 4.5, &amp; 8 Liter or Dry Ice Freeze Dryer</b>	Water	Rotary Vane	<b>1472100</b>	<b>7739402</b>	<b>1467700</b>	<b>7739403</b>
	Acids & Solvents	Hybrid	<b>7584000</b>	<b>7584002</b>		
	Acids & Solvents	Scroll	<b>7587100</b>	<b>7587100</b>	<b>7587000</b>	<b>7587000</b>
 <b>Console 6, 12 &amp; 18 Liter</b>	Water	Rotary Vane	<b>1472100</b>	<b>7739402</b>	<b>1467700</b>	<b>7739403</b>
	Acids & Solvents	Hybrid	<b>7584000</b>	<b>7584002</b>		
	Acids & Solvents	Scroll	<b>7587100</b>	<b>7587100</b>	<b>7587000</b>	<b>7587000</b>
 <b>Console 6, 12 &amp; 18 Liter with Stoppering Tray Dryer, Bulk Tray Dryer or Tall Clear Chamber</b>	Water	Rotary Vane			<b>1467700</b>	<b>7739403</b>
	Acids & Solvents	Scroll			<b>7587000</b>	<b>7587000</b>
 <b>Triad</b>	Water	Rotary Vane		<b>7739402</b>		<b>7739403</b>
	Acids & Solvents	Hybrid		<b>7584002</b>		
	Acids & Solvents	Scroll		<b>7587100</b>		<b>7587000</b>

\*VACUUBRAND™ and VACUUBRAND HYBRID™ are trademarks of VACUUBRAND GMBH + CO KG.

\*\*Faster freeze drying rates may be achieved by using pumps with larger displacement capacities.

# Vacuum Pumps & Accessories

## Ordering Information



### General Purpose Rotary Vane Vacuum Pumps

Catalog Number	Electrical Configuration	Displacement at 60 Hz (50 Hz) L/min	Dimensions (w x d x h)	Shipping Weight
<b>1472100</b>	115V, 50/60 Hz, 4.6A (Includes 115V NEMA 5-15P)	117 (98)	6.5" x 17.0" x 10.4"	62 lbs. (28 kg)
<b>7739402</b>	230V, 50/60 Hz, 2.4A (Includes 230V reverse IEC)	117 (98)	6.5" x 17.0" x 10.4"	62 lbs. (28 kg)
<b>1467700</b>	115V, 50/60 Hz, 7.8A (Includes 115V NEMA 5-15P)	195 (163)	6.5" x 18.5" x 10.4"	65 lbs. (30 kg)
<b>7739403</b>	230V, 50/60 Hz, 4.0A (Includes 230V reverse IEC)	195 (163)	6.5" x 18.5" x 10.4"	65 lbs. (30 kg)



### VACUUBRAND HYBRID\*\* Vacuum Pumps

Catalog Number	Electrical Configuration	Displacement at 60 Hz (50 Hz) L/min	Dimensions (w x d x h)	Shipping Weight
<b>7584000</b>	115V, 60 Hz, 5.7A (Includes 115V NEMA 5-15P)	115 (98)	20.0" x 12.0" x 9.1"	66 lbs. (30 kg)
<b>7584002</b>	230V, 50/60 Hz, 2.7A (Includes 230V reverse IEC)	115 (98)	20.0" x 12.0" x 9.1"	66 lbs. (30 kg)



### Scroll Vacuum Pumps

Catalog Number	Electrical Configuration	Displacement (L/min)	Dimensions (w x d x h)	Shipping Weight
<b>7587000</b>	115V/ 230V, 50/60 Hz, 10A/6A (Includes NEMA 5-15P and reverse IEC)	190	20.0" x 12.0" x 15.0"	59 lbs. (27 kg)
<b>7587100</b>	115V/ 230V, 50/60 Hz, 10A/6A (Includes NEMA 5-15P and reverse IEC)	103	20.0" x 12.0" x 15.0"	59 lbs. (27 kg)

### Rotary Vane and Combination Vacuum Pump Accessories

**1472200—Inlet Filter.** For Rotary Vane Vacuum Pumps 1472100, 7739402, 1467700 and 7739403. Prevents oil backstreaming from the pump and protects pump from submicron particle damage. Includes filter assembly and one filter cartridge. Life is approximately 1000 hours at  $1.33 \times 10^{-2}$  mBar (10 microns) vacuum. Shipping weight 1.0 lb. (0.5 kg)

**7584300—VACUUBRAND\*\* B-Oil.** One liter. Replacement oil for Combination Vacuum Pumps 7584000 and 7584002. Shipping weight 2.0 lbs. (0.9 kg)

**7541300—Vacuum Pump Oil.** One gallon (3.8 L) synthetic hydrocarbon oil. Shipping weight 12 lbs. (5 kg)

**1473500—Oil Return Kit.** Allows extended operation of the pump with the ballast open and helps to keep oil purged of contaminants. Consists of a stainless steel cylinder and tubing with clamp. When the excess oil collects in the filter, it is directed back to the pump to conserve oil. Shipping weight 0.5 lb. (0.2 kg)

**Vacuum Pump Oil.** Hydro-treated paraffinic hydrocarbon oil. Replacement oil for Rotary Vane Vacuum Pumps 1472100, 7739402, 1467700 and 7739403.

Catalog Number	Volume	Shipping Weight
<b>1988000</b>	One liter	2.0 lbs. (0.9 kg)
<b>1988001</b>	One gallon (3.8 L)	12 lbs. (5 kg)

### Scroll Vacuum Pump Accessories

**7587300—Pump Silencer.** Filters exhaust while silencing exhaust pump noise. Includes filter, centering ring and clamp to attach to exhaust outlet. Shipping weight 2.0 lbs. (0.9 kg)

**7587200—Tip Seal Kit for Scroll Vacuum Pump.** Tip Seal Replacement Kit provides all parts needed to replace tip seals in Scroll Vacuum Pumps. Includes two tip seals and O-rings. Labconco recommends replacing tip seals every 40,000 hours of pump use. Shipping weight 0.5 lbs (0.2 kg)

\*\*VACUUBRAND HYBRID™ is a trademark of VACUUBRAND GMBH + CO KG.

# Accessories

## Tray Dryer and Shelf

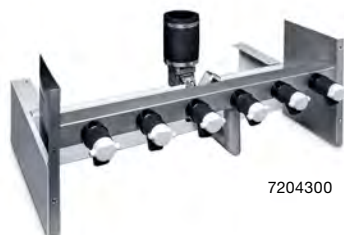

**7204300—6-Port Manifold with Isolation Valve.** For 1/2" or 3/4" flask adapters. **Not for use with Small Tray Dryers.** 30.1" w x 20.6" d x 13.5" h. Shipping weight 45 lbs. (21 kg)

**7726500—6-Port Tray Dryer Manifold.** Not field installable with 7761500. **Not for use with Small Tray Dryers.** 30.0" w x 16.5" d x 7.0" h. Shipping weight 19 lbs. (9 kg)

**7761500—Isolation Valve.** Separates tray and freeze dryers to shorten time necessary to reestablish working vacuum levels and provide a means for checking end point. Includes valve and handle, clamps and couplings. Not field installable with 7726500. **Not for use with Small Tray Dryers.** Shipping weight 5.0 lbs. (2.3 kg)

**7756300—Shelf Spacers.** Assist stoppering of partial loads of small serum bottles. 304 stainless steel. One pair. 9.0" w x 13.0" d x 2.5" h. Shipping weight 3.0 lbs. (1.4 kg)

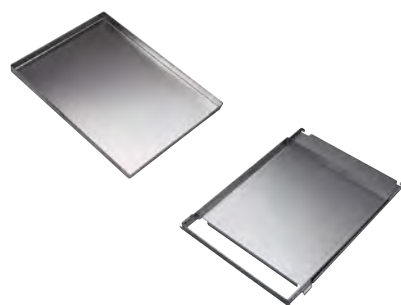

**Bulk Trays.** Contain pre-frozen liquids for bulk drying. 304 stainless steel with 0.9" lip. **Large Tray not for use with Small Tray Dryer.** Shipping weight 3.0 lbs. (1.4 kg)

**7377900—Small.** 10.3" x 11.6"

**7756200—Large.** 12.4" x 14.5" Compatible with Stoppering Tray Dryer, Bulk Tray Dryer, and Triad

**7756100—Tray with Slide-Out Bottom.** Stainless steel. **Not for use with Small Tray Dryer.** 12.0" w x 14.0" d. Shipping weight 5.0 lbs. (2.3 kg)



**7369600—Microwell Plate Holder.** Holds a 127.8 x 85.5 mm microplate. 5.7" w x 8.0" d x 0.7" h. One each. Aluminum. **Microplate not included.** Shipping weight 2.0 lbs. (0.9 kg)



**Rectangular Test Tube & Microcentrifuge Tube Racks.** 304 stainless steel. 12.0" w x 10.0" d x 2.5" h. Holds up to 70 each 12-13 mm test tubes or microcentrifuge tubes. **Tubes not included.**

**7370000—Test Tube Rack.** Shipping weight 2.8 lbs. (1.3 kg)

**7370001—Microcentrifuge Tube Rack.** Includes adapter plate for microcentrifuge tubes. Shipping weight 3.5 lbs. (1.6 kg)



**7439300—Microcentrifuge Tube Holder.** 3.0" w x 2.25" d x 1.0" h. Holds twelve 1.7 ml tubes. Anodized aluminum. One each. May be placed on any flat freeze drying surface. **Tubes not included.** Shipping weight 0.6 lb. (0.3 kg)



**7516200—Support Grid.** Stainless steel tray with removable plastic grid holds 144 containers of 12 mm dia. 7.0" w x 7.0" d. Shipping weight 2.5 lbs. (1.1 kg)

# Accessories

## Chambers



**304 Stainless Steel Drying Chambers.** Clear lid with neoprene gasket and valves and plastic molded knobs. For 1/2" and 3/4" flask adapters.

**7522800—12-Port.** 304 stainless steel chamber with 1/2" thick acrylic lid and twelve neoprene valves. 8.0" dia. x 9.75" h. Shipping weight 11 lbs. (5 kg)

**7522801—12-Port.** PTFE-coated 304 stainless steel chamber with 1/2" thick acrylic lid and twelve neoprene valves. 8.0" dia. x 9.75" h. Shipping weight 11 lbs. (5 kg)



**7522900—16-Port.** 304 stainless steel chamber with 3/4" thick acrylic lid and sixteen neoprene valves. 13.0" dia. x 13.0" h. Shipping weight 21 lbs. (10 kg)

**7522901—16-Port.** PTFE-coated 304 stainless steel chamber with 3/4" thick acrylic lid and sixteen neoprene valves. 13.0" dia. x 13.0" h. Shipping weight 21 lbs. (10 kg)

**7555200—0-Port.** 304 stainless steel chamber with 3/4" thick glass lid, vacuum release valve, and pass-through for electrical cords. For use with 7317100 product shelves. 13.0" dia. x 13.0" h. Shipping weight 21 lbs. (10 kg)



**Clear Chambers with Valves.** For bulk drying with flask drying option. Includes acrylic base, anodized aluminum lid, and eight neoprene valves with molded plastic knobs. For 1/2" and 3/4" flask adapters. 8" dia. opening and cap for 3" dia. attachment port.

**7318802—Short.** For use with 7317100 product shelves. 12.0" ID dia. x 15.0" h. Shipping weight 22 lbs. (10 kg)

**7318800—Tall.** For use with 7317100 and 7317200 product shelves. 12.0" ID dia. x 22.8" h. Shipping weight 25 lbs. (11 kg)



**Clear Chambers.** For view of product shelves during bulk drying. Includes acrylic lid and base, neoprene gasket, vacuum release valves and pass-through for electrical cords. 8" dia. opening and cap for 3" dia. attachment port on console freeze dryer.

**7318702—Short.** For use with 7509200, 7509201 and 7317100 product shelves. 12.0" ID dia. x 16.5" h. Shipping weight 17 lbs. (8 kg)

**7318700—Tall.** For use with 7509400, 7509401 and 7317200 product shelves. 12.0" ID dia. x 24.3" h. Shipping weight 20 lbs. (10 kg)

# Accessories

## Product Shelves & Test Tube Racks



**Product Shelves.** For bulk samples, microwell plates or serum bottles. Aluminum 10" dia. with 1/4" rims, three steel support rods and rubber feet. **Requires Chamber (not included).**

**7317100—Three.** Overall height: 9.8".  
Shipping weight 4.5 lbs. (2.0 kg)

**7317200—Five.** Overall height: 17.5".  
Shipping weight 7.0 lbs. (3.2 kg)



**Heated Product Shelves.** Aluminum with 1/4" rims, three stainless steel support rods and rubber feet. Nine clips for height adjustment, low voltage transformer with variable heat control to +40° C (+104° F). **Requires Chamber (not included).**

**7509200—Short.** 6.5" dia. x 9.0" h. 115V, 50/60 Hz.  
For chamber 7318702  
Shipping weight 13 lbs. (6 kg)

**7509400—Tall.** 10.0" dia. x 11.75" h. 115V, 50/60 Hz.  
For chamber 7318700  
Shipping weight 15 lbs. (7 kg)

**7509201\*—Short.** 6.5" dia. x 9.0" h. 230V, 50/60 Hz.  
For chamber 7318702  
Shipping weight 13 lbs. (6 kg)

**7509401\*—Tall.** 10.0" dia. x 11.75" h. 230V, 50/60 Hz.  
For chamber 7318700  
Shipping weight 15 lbs. (7 kg)

\*International electrical configuration



**Round Test & Microcentrifuge Tube Racks.** 304 stainless steel. 9.0" dia. x 2.5" h. Holds up to 104 each 12-13 mm test tubes or microcentrifuge tubes. For use with 7317100, 7317200 and Heated Product Shelf Chambers with nine-digit catalog numbers. **Tubes not included.**

**7379000—Round Test Tube Rack.** Shipping weight 2.8 lbs. (1.3 kg)

**7379001—Microcentrifuge Tube Rack.** Includes adapter plate for microcentrifuge tubes. Shipping weight 2.8 lbs. (1.3 kg)

# Drying Accessories

## Heated Shelf Chambers



**Heated Product Shelf Chambers with Valves.** For bulk drying and flask drying. Eight ports accommodate both 1/2" and 3/4" flask adapters. Includes 12" dia. acrylic cylinder and base, 10" dia. removable shelves, and temperature probes. Controlled heat settings -20 C (-4F) to + 60 C (+140F). Shelves do not cool. Overall dimensions: 13.5" w x 16.8" d x 14.2" h or 21.8" h. Has 8" dia. opening and cap for 3" dia. attachment port.



**Heated Product Shelf Chambers.** For bulk drying solid samples or drying small serum bottles or vials. Include 12" dia. acrylic cylinder and base, 10" dia. removable shelves, temperature probes and vacuum release valve. Controlled heat settings -20 C (-4F) to + 60 C (+140F). Shelves do not cool. Overall dimensions: 13.5" w x 15.2" d. x 14.2" h or 21.8" h. Has 8" dia. opening and cap for 3" dia. attachment port.

7 8 0 8 0

Select of **NUMBER OF VALVES**. This is the sixth digit.

- 1 = Zero Valves
- 2 = 8 Valves

Select of **NUMBER OF SHELVES**. This is the seventh digit.

- 0 = 3 shelves
- 1 = 5 shelves

Select the **ELECTRICAL CONFIGURATION** and **OUTLET TYPE** of your freeze dryer. These are the eighth and ninth digits.

- 00 = 115V, 60 Hz, with 20A plug for North America
- 10 = 230V, 60 Hz, with plug for North America
- 15 = 230V, 60 Hz, with plug for Saudi Arabia
- 30 = 230V, 50 Hz, with Schuko plug
- 40 = 230V, 50 Hz, with plug for China/Australia
- 50 = 230V, 50 Hz, with plug for Great Britain (UK)
- 70 = 230V, 50 Hz, with plug for India
- 90 = 230V, 50 Hz, with Schuko, China/Australia, Great Britain (UK) and India



# Accessories

## Manifolds

**Manifolds.** 304 stainless steel with neoprene valves and molded plastic knobs. For 1/2" and 3/4" flask adapters.



**7201700—4-Port.** 8.6" w x 8.6" d x 11.2" h.  
Shipping weight 5.5 lbs. (2.5 kg)



**7201800—8-Port.** 8.6" w x 8.6" d x 15.7" h.  
Shipping weight 8.5 lbs. (3.9 kg)



**7522300—20-Port.** 27.4" w x 8.7" d x 11.0" h.  
Shipping weight 15 lbs. (7 kg)



**7201900—14-Port.** For Console models only.  
24.3" w x 10.6" d x 10.3" h.  
Shipping weight 21 lbs. (10 kg)



**7202000—28-Port.** For Console models only.  
24.3" w x 10.6" d x 18.3" h.  
Shipping weight 38 lbs. (17 kg)

# End-Zone™ Starter Kit & Add-On Kit

## Specifications & Ordering Information

**End-Zone** provides an alternative to visual inspection, eliminating the guesswork of knowing when lyophilization is complete. End-Zone alerts when sample moisture levels are below your specified value. Lyo-Works shows the end point alert on your freeze dryer's display and, if programmed, sends an email.



End-Zone Starter Kit 780901000 connected to FreeZone 4.5 Liter Benchtop Freeze Dryer 700401000 with 8-Port Manifold 7201800



**Starter Kit** has all the components needed to detect end point in one 600 ml or larger Fast-Freeze Flask:

- 26-pin cable for connecting End-Zone sensors to any FreeZone Freeze Dryer with Lyo-Works (freeze dryer sold separately)
- Holder mountable to the freeze dryer with space for up to six sensors
- Two vacuum sensors—a sample sensor for placement in the Fast-Freeze Flask and a reference sensor for placement in an empty valve port
- Valve adapter to facilitate connection of sensor to empty valve port
- Fast-Freeze Flask top with opening for insertion of the vacuum sensor (flask bottom is required)
- Up to four End-Zone Add-On Kits may be used at once

**780901000—End-Zone Starter Kit.** Includes powder-coated steel 6-position sensor holder, two vacuum sensors with communication cables, one valve adapter and one top for 600 ml or larger Fast-Freeze Flask. FreeZone Freeze Dryer with Lyo-Works OS, drying chamber or manifold, vacuum pump, 600 ml or larger Fast-Freeze Flask and Adapter are required for operation. **Not for use with Stoppering or Bulk Tray Dryers.** Shipping weight 3.0 lbs. (1.4 kg)

**780902000—End-Zone Add-On Kit.** Includes one vacuum sensor with communication cable, one valve adapter, one top for 600 ml or larger Fast-Freeze Flask. Requires 780901000. Shipping weight 3.0 lbs. (1.4 kg)

# Accessories

## Stoppering Chambers & Optional Lids



**7569000—Mini Stoppering Chamber.** For freeze drying samples in small bottles with split stoppers. Attaches to valve on any Labconco Drying Chamber or Manifold, to stopper bottles under vacuum. For up to forty-eight 2 ml bottles or eight 30 ml serum bottles. Stoppering travel distance is 0.5". Using zero, one or two of the spacers provided, the chamber can accommodate bottles that range in height from 1.38" to 2.48". Includes one tray, two spacers; 1" OD and 1/2" ID PVC tubing, 36" long; two hose clamps; and 1/2" dia. stainless steel connector. Shipping weight 15 lbs. (7 kg)  
@ **WARNING:** Cancer—P65Warnings.ca.gov (California only)



**Clear Stoppering Chambers.** For an economical means of stoppering serum bottles under vacuum. Includes acrylic chamber and 3/4" thick attachment port base, stainless steel top plate, two 10" dia. aluminum shelves and low voltage transformer with variable heat control to +40° C (+104° F). 3/4" thick base has neoprene gasket and pass-through for electrical transformer cord. When lyophilization is complete, handle is turned to collapse top plate onto shelves, stoppering samples under vacuum. For use with small containers from 2 - 5 ml.

**7868020—115V, 50/60 Hz.** Shipping weight 30 lbs. (14 kg)

**7868030—230V, 50/60 Hz.** Shipping weight 30 lbs. (14 kg)



**Optional Lids.** For added protection against solvents and corrosives that attack acrylic, such as acetonitrile. Lid has 3" dia. hole for direct connection of a chamber or manifold to the collector. Includes cap for closing port when not in use.

**7207400—Stainless steel.** 14.0" dia.  
Not for use with 2.5 L models.  
Shipping weight 5.0 lbs. (2.3 kg)

**7207500—Stainless steel.** 10.1" dia.  
For use with 2.5 L models only.  
Shipping weight 5.0 lbs. (2.3 kg)



**7208200—Acrylic.** 14.0" dia.  
Shipping weight 5.0 lbs. (2.3 kg)

**7439902—Glass.** 14.0" dia.  
For use with 16-Port Drying Chamber and 6, 12 and 18 L models only.  
Shipping weight 3.5 lbs. (1.6 kg)

**7439900—Glass.** 9.25" dia.  
For use with 12-Port Drying Chamber.  
Shipping weight 2.0 lbs. (0.9 kg)

# Accessories

## Secondary Traps



**Secondary Traps.** Fits between the freeze dryer and vacuum pump to prevent particulate contaminants from entering the pump.

@ **WARNING:** Cancer—P65Warnings.ca.gov (California only)

**7386500—HEPA Filter Trap.**

Shipping weight 15 lbs. (7 kg)

**Chemical Trap.** Connect between the freeze dryer and vacuum pump for additional pump protection.



**7815302—Clear Polypropylene Canister with stand.**

For use with any trap insert listed below. Shipping weight 5.0 lbs. (2 kg)

**Trap Inserts.** Shipping weight 4.0 lb. (1.8 kg)

**7814800—Acid.** Contains acid neutralizing desiccant which changes from off-white to purple when exhausted.

**7814900—Moisture.** Contains desiccant which changes from blue to pink when exhausted.

**7815000—Radioisotope.** Contains activated carbon.

**7815200—Solvent.** Contains molecular sieve.

**7995600—Ammonia.** Contains impregnated carbon.



**7394800—Liquid Nitrogen Secondary Trap.** For samples with ultra low eutectic points.

Liquid nitrogen cools to  $-196^{\circ}\text{C}$  ( $-321^{\circ}\text{F}$ ) to trap contaminants. Powder-coated steel.

3/4" OD inlet and outlet connections. Includes insulated filler tube for connection of user-supplied liquid nitrogen tank, 20" wire-reinforced PVC tubing, 3/4" ID and two clamps.

**Liquid nitrogen is required (not included).** Shipping weight 24 lbs. (11 kg)

@ **WARNING:** Cancer—P65Warnings.ca.gov (California only)



**7538000—Dry Ice Secondary Trap.** For samples with low eutectic points. Dry ice and

solvent cools the insulated well to approximately  $-75^{\circ}\text{C}$  ( $-103^{\circ}\text{F}$ ). When used alone, it may serve as an inexpensive collector. Connect a sample directly to the incoming port and add a vacuum pump to the outgoing port. Ice trapping capacity of 900 ml. Includes 3.1 L well

and 3/4" OD inlet and outlet connections. **Dry ice and solvent, such as alcohol, are required (not included).** Shipping weight 9.0 lbs. (4.1 kg)

# Accessories

## Fast-Freeze™ Flasks

**Fast-Freeze Flasks.** Flasks should be filled to no more than one-third of their volume. Includes silicone top, glass bottom and a supply of filter paper. Amber-colored glass helps to protect light-sensitive samples and is available in four sizes. Clear available in 10 sizes.

**Adapters are required (not included).**

- Compatible with all major brands of laboratory freeze dry apparatus
- Variety of adapters available
- No complex filter retainer is necessary. One hundred filters supplied with each flask
- High strength borosilicate glass bottom to withstand extreme temperatures and high vacuum
- Entire flask may be autoclaved



Flask Size	Catalog Number		Flask Top Diameter*	Flask Bottom Dimensions (h x d)	Shipping Weight
	Clear Flask	Amber Flask			
40 ml	7540000		1/2"	76 x 34 mm	1.0 lb. (0.5 kg)
80 ml	7540200		1/2"	115 x 34 mm	1.0 lb. (0.5 kg)
120 ml	7540300		3/4"	68 x 59.2 mm	1.0 lb. (0.5 kg)
150 ml	7540400		3/4"	85 x 59.2 mm	1.0 lb. (0.5 kg)
300 ml	7540600	7540601	3/4"	145 x 59.2 mm	1.5 lbs. (0.7 kg)
600 ml	7540800	7540801	3/4"	135 x 90.2 mm	2.0 lbs. (0.9 kg)
750 ml	7541100	7541101	3/4"	162 x 90.2 mm	2.0 lbs. (0.9 kg)
900 ml	7540900	7540901	3/4"	190 x 90.2 mm	2.2 lbs. (1.0 kg)
1200 ml	7541000		3/4"	240 x 90.2 mm	2.2 lbs. (1.0 kg)
2000 ml	7541200		3/4"	380 x 90.2 mm	2.2 lbs. (1.0 kg)



**7544810—Replacement Filter Paper.** 1000 (10 packages of 100). 1" dia. (28mm). Pore size 17 microns. Shipping weight 0.5 lb. (0.2 kg)

\*Valves on the freeze dryers, drying chambers and manifolds fit adapters with both 1/2" and 3/4" dia.

# Accessories

## Fast-Freeze™ Adapters

**Flask Adapters.** Connect Fast-Freeze Flasks to the valve ports on your drying chamber or manifold. Borosilicate glass or stainless steel adapters in 1/2" and 3/4" dia. **Required for operation.** Shipping weight 0.5 lb. (0.2 kg)



Straight Stainless Steel	
7547000	1/2" to 1/2"
7547200	3/4" to 3/4"

Straight Borosilicate Glass	
7545000	1/2" to 1/2"
7545200	3/4" to 3/4"
7545400	1/2" to 3/4" and 3/4" to 1/2"

45° Bend Stainless Steel	
7547400	1/2" to 1/2"
7547600	3/4" to 3/4"

45° Bend Borosilicate Glass	
7545600	1/2" to 1/2"
7545800	3/4" to 3/4"
7546000	1/2" to 3/4" and 3/4" to 1/2"



**7543800—Stainless Steel Adapter 29/32.** Allows connection of 29/32 round bottom flasks to valve ports on drying chambers and manifolds. Shipping weight 1.0 lb. (0.5 kg)



**7543900—Aseptic Adapter.** For use with Fast-Freeze Flasks in place of an adapter. Allows a flask to be filled under sterile conditions prior to lyophilization and transported in a closed position before and after. 3/4" OD for connection between a Fast-Freeze Flask and a valve port on any Labconco Drying Chamber or Manifold. Corrosion-resistant PTFE. 1.75" w x 0.75" d x 3.2" h. Shipping weight 0.5 lb. (0.2 kg)



**7540100—FreeZone Freeze Dry Glassware Kit.** Includes one each flask and adapters: 7540800 (600 ml) and 7540600 (300 ml), 7547200 (3/4" straight stainless steel) and 7547600 (3/4" 45° bend stainless steel). Shipping weight 5.0 lbs. (2.0 kg)

# Accessories

## Fast-Freeze™



**Tube Holders.** Stainless steel. Hold tubes in an upright position inside a Fast-Freeze Flask or Lyph-Lock Flask. **Tubes and glassware are not included.** Shipping weight 1.0 lb. (0.5 kg)

**7442600—Holds 15 tubes.** For 12 or 13 mm dia tubes. 144 h x 83.3 d mm. For flasks 750 ml or larger.

**7442700—Holds 30 tubes.** For 0.5, 1.0 and 2.0 ml microcentrifuge tubes. 139 h x 83.3 d mm. For flasks 750 ml or larger.

**7379400—Holds 9 tubes.** For 15 ml tubes. 170 h x 88.9 d mm. For flasks 900 ml or larger.

**7379500—Holds 4 tubes.** For 50 ml tubes. 30 h x 116 d mm. For flasks 900 ml or larger.



**7369700—Slant Freeze Flask Holder.** Slant freezing increases the surface area to volume ratio, maximizing freeze drying rate. Angle is manually adjustable from 5° to 35°. Powder-coated steel. 10.4" w x 4.5" d x 6.7" h. Shipping weight 3.5 lbs. (1.6 kg)



**Flask Holders.** Help to prevent sample meltback. Hold Fast-Freeze Flask containing the sample inside a larger Fast-Freeze Flask so that sample is insulated. Stainless steel. **Flasks not included.** Shipping weight 1.0 lb. (0.5 kg)

**7543300—Small.** For use with inner flasks 7540000 (40 ml), 7540200 (80 ml) and outer flasks 7541100 (750 ml), 7541101 (750 ml), 7540900 (900 ml), 7540901 (900 ml).

**7543400—Large.** For use with inner flasks 7540300 (120 ml), 7542400 (150 ml), 7540600 (300 ml), 7540601 (300 ml) and outer flask 7541000 (1200 ml).

# Accessories

## Serum Bottles & Ampules

**Serum Bottles.** Specifically designed for lyophilization with uniform thin walls to even freezing and drying. Serum Bottles, Stoppers and Seals supplied in packages of 100.



Size	20 mm Corkage	13 mm Corkage	Split Stoppers	Aluminum Seals
2 ml		<b>7575010</b>	<b>7576010</b>	<b>7577010</b>
3 ml		<b>7575210</b>	<b>7576010</b>	<b>7577010</b>
5 ml	<b>7573010</b>		<b>7576210</b>	<b>7577110</b>
10 ml	<b>7573210</b>		<b>7576210</b>	<b>7577110</b>
20 ml	<b>7573410</b>		<b>7576210</b>	<b>7577110</b>
30 ml	<b>7573610</b>		<b>7576210</b>	<b>7577110</b>
50 ml	<b>7573810</b>		<b>7576210</b>	<b>7577110</b>
100 ml	<b>7574010</b>		<b>7576210</b>	<b>7577110</b>
125 ml	<b>7574210</b>		<b>7576210</b>	<b>7577110</b>



**Seal Crimpers.** Secure tear-away Aluminum Seals. Shipping weight 3.0 lbs. (1.4 kg)

**7578000—For 13 mm corkage.**

**7578100—For 20 mm corkage.**

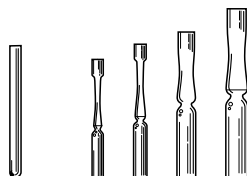

**Ampules.**  
Borosilicate glass.  
Package of 100.

Size	Straight	Pre-Scored Flat Bottom
1 ml	<b>7572710</b>	<b>7570610</b>
2 ml		<b>7570810</b>
5 ml		<b>7571010</b>
10 ml		<b>7571210</b>



**Ampule Pods.** Attach to a single drying chamber or manifold valve port. Polypropylene base with 15 silicone tubing ports, 15 plugs and two clamps. Include one straight stainless steel adapter for connection to a drying accessory valve port. 3.8" w x 3.8" d x 7.5" h. Shipping weight 2.5 lbs. (1.1 kg)

**7205100—1/4" ID tubing port dia.** For use with 7572710 and 7571010.

**7205101—3/8" ID tubing port dia.** For use with 7570610, 7570810 and 7571210.



**7593401—Ampule Valve Adapters.** Connect ampules to valve ports.  
Package of 10. Shipping weight 0.5 lb. (0.2 kg)



**7762700—Three Way Adapter.** Permits attachment of three ampules to a single valve port. Ampules are attached using Ampule Valve Adapters 7593401 or 1/8" surgical tubing (**valve adapters and tubing not provided**). Cavity in adapter body can be filled with cotton fiber media to help prevent contamination between samples. Shipping weight 0.2 lb. (0.1 kg)



**7578500—Oxygen/Natural Gas Sealing Torch.** Specifically designed for flame sealing freeze dry ampules. Seals all types of heat-resistant glass. Connects to natural gas, butane or propane and oxygen with 1/4" ID hose connectors. Shipping weight 3.0 lbs. (1.4 kg)



# FreeZone® Benchtop Shell Freezers

## Specifications & Ordering Information



### All models feature:

- Stainless steel and powder-coated steel exterior
- 1/2 hp HCFC/CFC-free refrigeration system to cool the heat transfer solution to -40° C (-40° F)
- Stainless steel bath, 5.5" w x 12.0" d x 6.5" h, surrounded by urethane foam insulation with white high-density polyethylene cover. Two chain-driven rollers, powered by a sparkless induction motor, rotate flasks up to 1200 ml. Approximately two liters of transfer solution are required (not included)
- LED temperature "wave" for display of bath temperature from -20° to -42° C (-4° to -43.6° F). LEDs illuminate amber as the system cools. When system reaches operating temperature, bottom LED illuminates green
- Retractable drain hose
- Fast-Freeze Flask capacity:
  - Two: 40 ml, 80 ml, 120 ml and 150 ml
  - One: 300 ml, 600 ml, 750 ml, 900 ml and 1200 ml
- Overall dimensions: 15.1" w x 22.1" d x 19.7" h
- Shipping weight 96 lbs. (44 kg)

### FreeZone Benchtop Shell Freezers.

For pre-freezing samples. Stainless steel bath has two rollers that rotate Fast-Freeze Flasks in a low temperature heat transfer solution, such as methanol or ethanol, so that a uniform thin coating of sample freezes to the interior surface of the container. Shell freezing increases the surface area to volume ratio, which facilitates efficient vapor flow from sample to collector during lyophilization.

### Models conform to the following standards:

- UL Standard 61010-1 (115/230V, 60 Hz models)
- CAN/CSA C22.2 No. 61010-1 (115/230V, 60 Hz models)
- CE Conformity marking (230V, 50 Hz models)

### Option includes:

- Region-specific electrical configurations

Catalog Number	Electrical Requirements	Plug Type
7949020	115V, 60 Hz, 6A	North America, 115V, 15A
7949040	230V, 60 Hz, 3A	North America, 230V
7949030	230V, 50 Hz, 3A	Schuko
7949060	230V, 50 Hz, 3A	British (UK)
7949070	230V, 50 Hz, 3A	China/Australia



# Accessories

## Carts, Shelves & Gauges



**Digital Electronic Vacuum Gauges.** LCD displays vacuum measurement in mBar, Torr or Pa. Range is 0.02 to 5 mBar. Stainless steel and powder-coated steel casing. 8.1" w x 4.1" d x 6.4" h. Include a cord with 3/8" to 1/2" OD adapter for connection to either vacuum tubing or a valve on a drying accessory. May be used as an accessory by the Dry Ice Benchtop Freeze Dryer or other freeze dryers. For use with Dry Ice Benchtop Freeze Dryer. Shipping weight 10 lbs. (5 kg)

**7395000—115V, 60 Hz, 0.4A.**

**7395001\*—230V, 50 Hz, 0.2A.**

\*International electrical configuration



**7368700—FreeZone Cart.** Powder-coated steel. 5.0" dia. casters. Bottom shelf accommodates a vacuum pump. 23.3" between shelves. Load capacity of 450 lbs. (204 kg). 28.0" w x 28.0" d x 31.3" h. Shipping weight 120 lbs. (54 kg)



**7426400—Support Shelves.** Attach easily to Benchtop Freeze Dryers to support large flasks attached to the drying chamber or manifold. Shelf height is adjustable. One pair. Powder-coated steel. Each shelf is 7.4" w x 12.0" d. Shipping weight 2.0 lbs. (0.9 kg)

# FreeZone® Freeze Dryers

## Specifications

### All models feature:

- \* Full color, 5" capacitive touch screen with Lyo-Works OS:
  - Real time display of collector temperature, vacuum level and optional End-Zone end point detection
  - Automatic and manual start-up modes for collector cool down and vacuum pull down
  - Vacuum set point, alerts, diagnostic tests, user manual, defrost control and optional drying accessory control
  - Data logging stores and displays data in table or graph format, and may be exported via USB
  - Settings include language (English, Spanish, French, German, Italian, Portuguese, Chinese, and Japanese), time, temperature (° C or ° F) and vacuum (mBar, Torr or Pa)
  - Alerts can be emailed to user-entered addresses via Ethernet connection
  - Diagnostics and QR Resources
  - Maintenance alert settings for vacuum pump and refrigeration
  - Security lock-out

### \* USB port and Ethernet connection

- End-Zone compatible (End-Zone Starter Kit sold separately. (See page 26)
- Vacuum control valve and break valve
- \* Patented\* vacuum line moisture sensor
- Stainless steel and powder-coated steel exterior
- Quick-disconnect drain hose fitting with hose connector. 18" of 1/4" ID silicone tubing and clamp included
- Collectors reaching -50° C include acrylic lid. Collectors reaching -84° C or -105° C include stainless steel lid
- Hot gas defrost with auto shut off at +60° C (+140° F)

### Benchtop models also feature:

- Upright stainless steel collector coil capable of holding 2.5, 4.5 or 8 liters of ice before defrosting. Collector lid, 3/4" thick, has neoprene gasket and 3" dia. port to connect drying accessories (sold separately)
- Electrical receptacle for vacuum pump connection
- 3/4" OD vacuum connection, 50" of 3/4" ID vacuum hose and two clamps

### Console models also feature:

- Upright stainless steel collector coil capable of holding 6, 12 or 18 liters of ice before defrosting. Collector lid, 3/4" thick, has neoprene gasket
- Console cabinet with interior space for vacuum pump (sold separately) and two-piece, removable front panel with viewing window
- Clear acrylic chamber lid, 3/4" thick, with neoprene gasket
- Exterior electrical receptacle for vacuum pump connection

- 3/4" OD vacuum connection, 36" of 3/4" ID vacuum hose and two clamps

### Standards conformance & regulations:

- UL Standard 61010-1 (115/230V, 60 Hz models)
  - CAN/CSA C22.2 No. 61010-1 (115/230V, 60 Hz models)
  - CE Conformity marking (230V, 50 Hz models)
- @ **WARNING:** Cancer – P65Warnings.ca.gov (California only)

### Benchtop options include:

- **For 2.5 and 4.5 L:** Single 1/3 hp HCFC/CFC-free refrigeration system to cool collector to ~-50° C (~-58° F), two 1/3 hp HCFC/CFC-free refrigeration systems to cool collector to ~-84° C (~-119° F) or **for 4.5 L only:** two 1/2 hp HCFC/CFC-free refrigeration systems to cool collector to ~-105° C (~-157° F) at 60 Hz or ~-102° C (~-152° F) at 50 Hz. **For 8 L:** Single 3/4 hp HCFC/CFC-free refrigeration system to cool collector to ~-50° C (~-58° F)
- PTFE-coated collector coil and chamber for corrosive compounds
- Region-specific electrical plug configurations

### Console options include:

- Single 3/4 hp (6 L), 1 hp (12 L) or 1-1/2 hp (18 L) HCFC/CFC-free refrigeration system to cool collector to ~-50° C (~-58° F) or two 1/3 hp (6 L) or 3/4 hp (12 L) HCFC/CFC-free refrigeration systems to cool collector to ~-84° C (~-119° F)
- Purge valve - temporarily isolates vacuum from the system to optimize performance before or after freeze drying
- PTFE-coated collector coil and chamber for corrosive compounds
- Built-in shell freezer with stainless steel bath, 5.5" w x 12.5" d x 7.5" h, that includes 1/2 hp HCFC/CFC-free refrigeration system to cool heat transfer solution to -40° C (-40° F), 3/4" thick high-density polyethylene lid, neoprene gasket and quick-disconnect drain hose fitting and 18" of 1/4" ID silicone tubing with clamp (6 L -50° C only)
- Built-in stainless steel mini vacuum drying chamber, 5.1" w x 13.0" d x 2.5" h, that includes 50-watt heater with microprocessor control to +60° C (+140° F), 3/4" thick clear acrylic lid and neoprene gasket. (Chamber is not cooled.)
- Region-specific electrical plug configurations

### All models require (not included):

- Vacuum pump with a displacement of at least 98 L/min, 0.02 mBar ultimate pressure and fitting for 3/4" ID vacuum hose. See pages 19-20
- Drying accessory. See pages 14-15, 17-18, 22, 24-25
- Freeze dry glassware if not bulk freeze drying. See pages 29-32

\* Labconco exclusive feature  
\*U.S. Patent No. 6,968,631



# FreeZone® Triad® Freeze Dryers

## Specifications

### All models feature:

- \* Stainless steel collector coil capable of removing 1.84 L of water in 24 hours and holding 2.5 L of ice before defrosting\*
- \* Two 1/3 hp HCFC/CFC-free refrigeration compressors cool the collector to  $\approx -85^{\circ}\text{C}$  ( $\approx -121^{\circ}\text{F}$ ) and work in concert with a 1000-watt heater to cool and heat fluid medium circulating through channels in the shelf. Not for use with samples containing methanol or ethanol
- Processing shelf, 12.4" w x 14.5" d. Spacing between shelf and top of chamber accommodates containers with stoppers up to 148 mm maximum height
- One probe for monitoring temperature of sample in chamber
- Temperature ramp and hold programming from  $\approx -55^{\circ}\text{C}$  to  $\approx +50^{\circ}\text{C}$  ( $\approx -67^{\circ}\text{F}$  to  $\approx +122^{\circ}\text{F}$ ) and  $\approx -75^{\circ}\text{C}$  ( $\approx -103^{\circ}\text{F}$ ) during pre-freezing. Controls temperature to  $\pm 1^{\circ}\text{C}$  of set point. Memory to store 30 programs with 16 segments each including number of steps, ramp rate, shelf temperature, hold time and vacuum level
- \* Full color, 5" capacitive touch screen with Lyo-Works OS:
  - Real time display of collector temperature and vacuum level
  - Creation and storage for up to 30 programs with up to 16 steps each. Ability to set ramp rate, shelf temperature, shelf temperature time and vacuum set point per step
  - Manual start-up buttons for collector and shelf temperature control and vacuum pull down
  - Alerts, diagnostic tests, user manual and defrost control
  - Data logging stores and displays data in table or graph format, and may be exported via USB or Ethernet
  - Settings include language (English, Spanish, French, German, Italian, Portuguese, Chinese, and Japanese), time, temperature ( $^{\circ}\text{C}$  or  $^{\circ}\text{F}$ ) and vacuum (mBar, Torr or Pa)
  - Alerts can be emailed to user-entered addresses via Ethernet connection
  - Vacuum pump maintenance alert
  - Security lock-out
  - Diagnostics
  - QR Resources

- \* Pneumatic stoppering mechanism with diaphragm and plate.  
**No compressed gas is required**
- Stoppering control knob, vacuum release control knob and 1/8" OD user-supplied sterile/inert gas backfill port
- Four left side-mounted neoprene valves with molded plastic knobs and fittings that accommodate 1/2" and 3/4" flask adapters
- \* USB port and Ethernet connection
- Electrical receptacle for vacuum pump
- Hot gas defrost with stainless steel drain pan, silicone drain hose and auto shut off at  $+60^{\circ}\text{C}$  ( $+140^{\circ}\text{F}$ )
- Vacuum control valve
- \* Vacuum break valve
- Stainless steel and powder-coated steel exterior
- Clear acrylic door, 1" thick, with silicone gasket and latch
- 3/4" OD vacuum connection. 36" long, 3/4" ID vacuum hose with two clamps

### Standards conformance & regulations:

- UL Standard 61010-1 (115/230V, 60 Hz models)
- CAN/CSA C22.2 No. 61010-1 (115/230V, 60 Hz models)
- CE Conformity marking (230V, 50 Hz models)

@ **WARNING:** Cancer — P65Warnings.ca.gov (California only)

### Options include:

- Region-specific electrical plug configurations

### All models require (not included):

- Vacuum pump with a displacement of at least 98 L/min, 0.02 mBar ultimate pressure and fitting for 3/4" ID vacuum hose. See pages 19-20
- Freeze dry glassware if not bulk freeze drying. See pages 29-32

\* Freeze drying rate will be lower for samples other than plain water. For optimum performance, room temperature should be  $21^{\circ}\text{C}$  ( $70^{\circ}\text{F}$ ) or colder.

\* Labconco exclusive feature



# FreeZone® Stoppering Tray Dryers

## Specifications

### All models feature:

- Three adjustable shelves, each 12.0" w x 16.5" d with 196 square inches of area. Spacing between the shelves accommodates containers with stoppers up to a maximum height of 75 mm and minimum height of 38 mm when three shelves are used, a maximum height of 107 mm and minimum height of 56 mm when two shelves are used, and a maximum height of 196 mm and minimum height of 114 mm when one shelf is used
- 1 hp HCFC/CFC-free refrigeration system and 1000-watt electric heater for cooling and heating fluid medium circulating through channels in the shelves from -40° C to +40° C (-40° F to +104° F). Controls circulating fluid temperature to  $\pm 1^\circ$  C of set point
- Three probes for monitoring sample or shelf temperature
- Temperature ramp and hold programming from -40° C to +40° C (-40° F to +104° F) and memory to store 30 programs with 16 segments each, including number of steps, ramp rate, shelf temperature, hold time and vacuum level
- \* System programming that is displayed on the FreeZone 6, 12 or 18 Liter Freeze Dryer (freeze dryer sold separately or as one catalog number): Manual or Program mode; probe temperatures in ° C or ° F; vacuum in mBar, Torr or Pa; segment of the program that is in progress; time remaining in present segment; alarms for power failure; supply line voltage outside of limits; system temperature variation  $> \pm 2^\circ$  C, vacuum variation progress bar, diagnostics, and QR resources  $> 0.500$  mBar; failure to reach system set point temperature; and program completed
- \* Data logging that displays and stores data in table or graph on the FreeZone 6, 12 or 18 Liter Freeze Dryer (freeze dryer sold separately or as one catalog number). Export data via USB or Ethernet
- Stoppering mechanism that inflates a diaphragm via atmospheric pressure. **No compressed gas is required**
- Stoppering Raise/Lower control knob, vacuum release Open/Close control knob and 1/8" OD backfill port for user-supplied air or gas
- Stainless steel and powder-coated steel exterior
- Acrylic door, 1" thick, with silicone gasket and latch
- 3" dia. outlet, located on the bottom of the tray dryer cabinet, for connection to a FreeZone 6, 12 or 18 Liter Console Freeze Dryer (freeze dryer is required and not included)
- Integral support stand
- Overall dimensions (tray dryer only): 32.4" w x 24.6" d x 27.1" h

### Standards conformance & regulations:

- UL Standard 61010-1 (115/230V, 60 Hz models)
- CAN/CSA C22.2 No. 61010-1 (115/230V, 60 Hz models)
- CE Conformity marking (230V, 50 Hz models)

### Options include:

- 6-Port Tray Dryer Manifold, 30.0" w x 16.5" d x 7.0" h. Available only when ordering the FreeZone Stoppering Tray Dryer as a separate component. See page 21
- Isolation Valve. Available only when ordering the FreeZone Stoppering Tray Dryer as a separate component. See page 21
- Region-specific electrical plug configurations

### All models require (not included):

- FreeZone 6, 12 or 18 Liter Console Freeze Dryer with Lyo-Works OS. FreeZone Stoppering Tray Dryer and Freeze Dryer may be ordered as separate components or together as one catalog number on selected models of FreeZone 6, 12 or 18 Liter Console Freeze Dryers. See page 11
- Vacuum pump with a displacement of at least 163 L/min, 0.02 mBar ultimate pressure and fitting for 3/4" ID vacuum hose. See pages 19-20
- Freeze dry glassware if not bulk freeze drying. See pages 29-32

\* Labconco exclusive feature



# FreeZone® Bulk & Small Tray Dryers

## Specifications

### All models feature:

- \* 200-watt heater on each shelf for heating to +60° C (+140° F). Maintains system temperature within 3° C of set point. (Shelves are not cooled by the Tray Dryer. Samples must be pre-frozen)
- Three sensor probes for monitoring sample temperature. Connections for two additional sensors are provided (additional sensors sold separately)
- \* Data logging, when enabled, stores and displays data in table or graph on the FreeZone Freeze Dryer. (Freeze dryer sold separately. Export data via USB or Ethernet)
- Vacuum release valve with knob
- Stainless steel and powder-coated steel exterior
- Acrylic door, 1" thick, with silicone gasket and latch

### Bulk Tray Dryers also feature:

- Three shelves, each 12.7" w x 16.6" d to provide 210 square inches of area. Chamber may accommodate two additional shelves (additional shelves sold separately)
- \* System programming displayed on the FreeZone 6, 12 or 18 Liter Freeze Dryer (freeze dryer sold separately): Manual or Program mode; probe temperatures in °C or °F; vacuum in mBar, Torr or Pa; segment of the program in progress; time remaining in present segment; alarms; shelf temperature variation >±3° C; failure to reach shelf set point temperature ±3° C; and program completed
- 3" dia. outlet, located on the bottom of the tray dryer cabinet, for connection to a FreeZone 6, 12 or 18 Liter Console Freeze Dryer (freeze dryer sold separately)
- \* Integral support stand with attachment port for connection to FreeZone 6, 12 or 18 Liter Console Freeze Dryer (freeze dryer sold separately)
- Overall dimensions: 32.2" w x 21.5" d x 27.1" h

### Small Tray Dryers also feature:

- Three removable shelves with shelf sensors, each 10.6" w x 12.0" d to provide 127.2 square inches of area. Chamber can accommodate two additional shelves (additional shelves sold separately)
- \* System programming is displayed on any FreeZone 2.5, 4.5, 6, 8, 12 or 18 Liter Freeze Dryer (Freeze dryer sold separately. Manual or Program mode; probe temperatures in °C or °F; vacuum in mBar, Torr or Pa; segment of the program in progress; time remaining in present segment; end of program; alarms; supply line voltage outside of limits; system temperature variation >±2° C, vacuum variation >0.500 mBar; failure to reach system set point temperature; and program completed
- Overall dimensions: 15.3" w x 18.5" d x 18.1" h

### Standards conformance & regulations:

- \* Labconco exclusive feature

- UL Standard 61010-1 (115/230V, 60 Hz models)
- CAN/CSA C22.2 No. 61010-1 (115/230V, 60 Hz models)
- CE Conformity marking (230V, 50 Hz models)

### Bulk Tray Dryer options include:

- 6-Port Tray Dryer Manifold, 30.0" w x 16.5" d x 7.0" h
- Isolation Valve

### Bulk Tray Dryer models require (not included):

- FreeZone 6, 12 or 18 Liter Console Freeze Dryer with Lyo-Works OS. See page 10-11
- Vacuum pump with a displacement of at least 163 L/min, 0.007 mBar ultimate pressure and fitting for 3/4" ID vacuum hose. See pages 19-20
- Freeze dry glassware if not bulk freeze drying. See pages 29-320

### Small Tray Dryer models require (not included):

- FreeZone 2.5 L, 4.5 L, 6 L, 8 L, 12 L, 18 L Freeze Dryer with Lyo-Works OS
- Vacuum pump with a displacement of at least 98 L/min, 0.02 mBar ultimate pressure and fitting for 3/4" ID vacuum hose. See pages 19-20
- Freeze dry glassware if not bulk freeze drying. See pages 29-32



# Everything you need to succeed.

## Chemical Ventilation

Fume Hoods  
Filtered Fume Hoods  
Ductless Enclosures

## Biological Ventilation

Biosafety Cabinets  
Clean Benches  
PCR Enclosures  
Lab Animal Enclosures

## Particulate Enclosures

Powder Containment  
Nanotechnology  
Glove Boxes

## Sample Preparation

Freeze Dryers  
Evaporators  
Concentrators  
Cold Traps

## Washers & Water

Glassware Washers  
Water Purification Systems

## Forensics

Fuming Chambers  
Drying Cabinets  
Downdraft Powder Stations

## Specialized Solutions

Kjeldahl, Fat & Crude Fiber  
Instruments  
Blood Drawing Chairs

## Lab Accessories & Parts

Vacuum Pumps  
Remote Blowers & Exhausters  
Filters & Pre-Filters  
Glassware  
Carts, Tables & Benches  
Base Stands, Cabinets &  
Work Surfaces

## Our promise.

You can expect straight talk from us.  
A fair and honest approach to doing  
business. And people you can trust to  
do the right thing.

When you buy equipment from us,  
it should work the way you need it to,  
and if it doesn't, we will take care of it.

Taking care of people is how we take  
care of business.



**Visit [labconco.com](https://labconco.com) to request information  
for all Labconco products.**

**LABCONCO CORPORATION**

8811 Prospect Avenue  
Kansas City, MO 64132

(800) 821-5525 | (816) 333-8811

[labconco.com](https://labconco.com)



©2023 LABCONCO CORPORATION  
Product design subject to change without notice.

3-40-3/17/23

